



# GSM communicator for fire alarm control panel G17F

## Installation manual

March, 2024



# Contents

<b>SAFETY PRECAUTIONS .....</b>	<b>3</b>
<b>1 DESCRIPTION.....</b>	<b>4</b>
1.1 SPECIFICATIONS .....	5
1.2 ELEMENTS OF THE <i>G17F</i> COMMUNICATOR.....	5
1.3 PURPOSE OF TERMINALS .....	6
1.4 LED INDICATION OF OPERATION .....	6
1.5 COMPONENTS NECESSARY FOR INSTALLATION .....	7
<b>2 QUICK CONFIGURATION USING <i>TRIKDISCONFIG</i> SOFTWARE.....</b>	<b>7</b>
2.1 SETTINGS FOR CONNECTING TO <i>PROTEGUS2</i> APP .....	8
2.2 SETTINGS FOR CONNECTING TO CENTRAL MONITORING STATION.....	10
<b>3 WIRING SCHEMATICS, INSTALLATION AND TURNING ON THE SYSTEM .....</b>	<b>11</b>
3.1 FASTENING .....	11
3.2 SCHEMATIC FOR CONNECTING THE COMMUNICATOR TO A FIRE CONTROL PANEL.....	12
3.3 SCHEMATIC FOR CONNECTING THE COMMUNICATOR TO AN INIM SMARTLINE FIRE CONTROL PANEL.....	12
3.4 <i>TRIKDISCONFIG</i> SETTINGS WHEN AN INIM SMARTLINE FIRE CONTROL PANEL IS CONNECTED.....	13
3.5 SCHEMATICS FOR CONNECTING INPUTS .....	14
3.6 SCHEMATIC FOR CONNECTING IO SERIES EXPANDER MODULES.....	15
3.7 SCHEMATIC FOR CONNECTING AN IO-8 EXPANDER MODULE.....	15
3.8 SCHEMATIC FOR CONNECTING THE W485 WIFI MODULE.....	16
3.9 SCHEMATIC FOR CONNECTING THE E485 “ETHERNET” MODULE.....	16
3.10 TURNING ON THE COMMUNICATOR.....	16
<b>4 REMOTE CONTROL .....</b>	<b>17</b>
4.1 ADDING THE COMMUNICATOR TO <i>PROTEGUS2</i> APP.....	17
4.2 CONFIGURATION AND CONTROL VIA SMS MESSAGES .....	17
4.3 CONTROL PGM OUTPUTS USING PHONE CALLS .....	19
<b>5 DESCRIPTION OF <i>TRIKDISCONFIG</i> WINDOWS .....</b>	<b>19</b>
5.1 DESCRIPTION OF <i>TRIKDISCONFIG</i> STATUS BAR .....	19
5.2 “SYSTEM OPTIONS” WINDOW .....	20
5.3 “REPORTING TO CMS” WINDOW .....	22
5.4 “USERS & REPORTING” WINDOW.....	23
5.5 “MODULES” WINDOW .....	25
5.6 “ZONES” WINDOW .....	27
5.7 “PGM” WINDOW .....	28
5.8 “SYSTEM EVENTS” WINDOW.....	28
5.9 “EVENTS LOG” WINDOW .....	29
5.10 RESTORE DEFAULT SETTINGS .....	30
<b>6 SETTING PARAMETERS REMOTELY .....</b>	<b>30</b>
<b>7 TESTING THE <i>G17F</i> GSM COMMUNICATOR .....</b>	<b>30</b>
<b>8 UPDATING FIRMWARE .....</b>	<b>31</b>



### Safety precautions

The communicator should be installed and maintained only by qualified personnel.

Please read this manual carefully prior to installation in order to avoid mistakes that can lead to malfunction or even damage to the equipment.

Always disconnect the power supply before making any electrical connections.

Any modifications, modernization or repairs not authorized by the manufacturer shall render the warranty void.



Please adhere to your local waste sorting regulations and do not dispose of this equipment or its components with household waste.



## 1 Description

Communicator **G17F** meets the requirements of standard EN 54-21:2006.

The product complies with the performance requirements of EN54-21 standard Annex A for type 1 transmission system type.

Communicator **G17F** Certificate No: 1922-CPR-1974. Fire detection and fire alarm systems. Alarm transmission and fault warning routing equipment.

The product is certified by notified product certification body: No.1922 "Dedal", Nesebar Mladost str. 50, Bulgaria, 8230

Trikdís technical support contacts: support@trikdis.lt, +37067422877

The **G17F** is used for transmitting fire alarm control panel messages via cellular network.

Principle of operation. When an input (zone) of the communicator is violated, the **G17F** will transmit an event message to the Central Monitoring Station's receiver or to the **Protegeus** app using mobile internet. It can also send SMS messages and make phone calls. The communicator is available with 2G or 4G modems.

## Features

### Messages to the security company

- Sends event information to TRIKDIS software and hardware receivers, which work with any monitoring software.
- Can send events to SIA DC-09 receivers.
- If connection via the main channel is lost, the messages are automatically sent to a backup receiver.
- Can report events to the Central Monitoring Station using SMS messages. Extremely useful because it works even when IP connectivity is disrupted in the mobile operator's network.
- Cellular network jamming recognition.
- Can simultaneously report events to the Central Monitoring Station and work with the **Protegeus2** app. It is possible to set priority for sending events to the Central Monitoring Station.
- Event messages are sent in Contact ID codes.

### Messages to users

- Calls selected phone numbers (up to 8 users).
- Sends SMS messages about events.
- "Push" and special sound event notifications using the **Protegeus** application.

### Remote control of outputs

- Via **Protegeus** app.
- By calling the device's phone number.
- Via SMS messages.

### Settings and installation

- Quick and easy installation.
- Device configuration either using an USB cable or remotely using **TrikdísConfig** software.
- Remote updating of firmware.
- Two access levels (types of accounts) for setting parameters: for the installer and for the administrator.

### Inputs and outputs

- 3 inputs, selectable type: NO, NC, EOL (10kΩ).
- 3 double purpose I/O terminals that can be set as input (IN) or output (OUT) terminals. Selectable input types: NO, NC, EOL (10 kΩ).
- RS485 bus for connecting **iO** series expander modules.





- Using *iO* series expanders, the number of inputs (IN) or outputs (OUT) can be increased to 12.

## 1.1 Specifications

Parameter	Description
GSM/GPRS modem frequencies	850 / 900 / 1800 / 1900 MHz
LTE modem frequencies	700 / 800 / 900 / 1800 / 2100 / 2600 MHz
Power supply voltage	9-32 V DC
Current consumption	100 mA
Transmission protocol	TRK, SIA DC-09_2007, SIA DC-09_2012
Encryption key	6 symbol encryption key.
Connection to CMS	TCP/IP or UDP/IP, SMS
Event codes	Contact ID codes.
Memory	Up to 60 messages.
Inputs and outputs	3 inputs, can be set as NO, NC, EOL=10 kΩ type. 3 double purpose terminals (IN/OUT), can be set as NO, NC, EOL=10 kΩ type inputs or open collector (OC) type outputs with current up to 100 mA.
Event memory	Up to 1000 events.
Configuration	Remotely using TriKdisConfig software or locally using USB Mini-B. Remotely using SMS messages.
Operating environment	Temperature from -10 °C to +50 °C, relative air humidity – up to 80% at +20°C.
Dimensions	92 x 62 x 25 mm
Weight	80 g

## 1.2 Elements of the *G17F* communicator

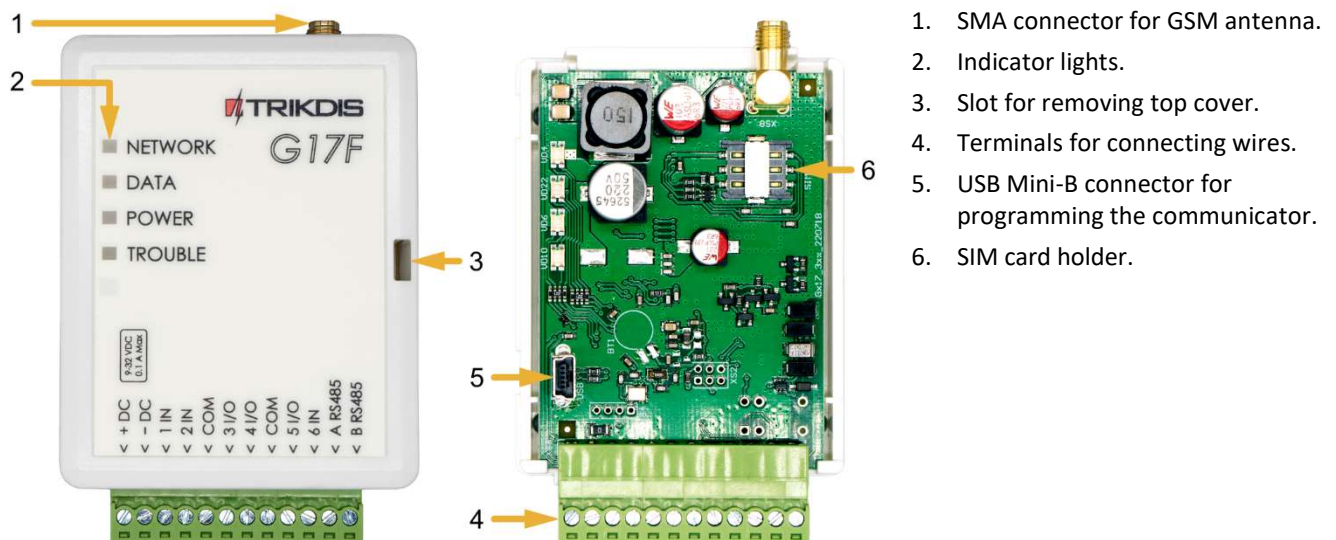



## 1.3 Purpose of terminals

Terminal	Description
+DC	Power supply terminal (9 - 32 V DC positive terminal)
-DC	Power supply terminal (9 - 32 V DC negative terminal)
1 IN	1 <sup>st</sup> input terminal, selectable type: NO, NC, EOL=10 kΩ (default setting)
2 IN	2 <sup>nd</sup> input terminal, selectable type: NO, NC, EOL=10 kΩ (default setting)
COM	Common (negative) terminal
3 I/O	3 <sup>rd</sup> double purpose terminal (IN/OUT), can be set as input of selectable type NO, NC, EOL=10 kΩ (default setting) or open collector (OC) type output with current up to 100 mA
4 I/O	4 <sup>th</sup> double purpose terminal (IN/OUT), can be set as input of selectable type NO, NC, EOL=10 kΩ (default setting) or open collector (OC) type output with current up to 100 mA
COM	Common (negative) terminal
5 I/O	5 <sup>th</sup> double purpose terminal (IN/OUT), can be set as input of selectable type NO, NC, EOL=10 kΩ (default setting) or open collector (OC) type output with current up to 100 mA
6 IN	6 <sup>th</sup> input terminal, selectable type: NO, NC, EOL=10 kΩ (default setting)
A RS485	RS485 terminals for connecting an <i>iO</i> input and output expander or other equipment
B RS485	

## 1.4 LED indication of operation

Indicator	Light status	Description
Network	Off	Not connected to GSM network
	Green solid and yellow blinking	The communicator is connected to GSM network. Sufficient GSM signal strength level for GPRS is 5 (five yellow flashes) and 3 for 4G (three yellow flashes).
Data	Green solid	Message is being sent
	Yellow solid	There are unsent events in the data buffer
Power	Green blinking	The power supply voltage is sufficient
	Yellow blinking	The power supply voltage is insufficient
	Green and yellow blinking	Configuration mode is on
Trouble	Off	No operational problems
	1 blink	No SIM card inserted
	2 blinks	The PIN code of the SIM card is incorrect
	3 blinks	Unable to connect to GSM network
	4 blinks	Unable to connect to the IP receiver using the primary channel
	5 blinks	Unable to connect to the IP receiver using the backup channel
	6 blinks	Internal clock of the <b>G17F</b> is not set
	8 blinks	Insufficient power supply voltage
	9 blinks	Problems with the connection to the RS485 module



## 1.5 Components necessary for installation

Before beginning installation, make sure that you have:

1. A USB Mini-B type cable for configuration.
2. At least 4-wire cable for connecting the communicator to the fire control panel.
3. A flat-head 2,5 mm screwdriver.
4. An external GSM antenna if network coverage in the area is poor.
5. An activated nano-SIM card (PIN code requests can be turned off).
6. The manual of the fire control panel that the communicator will be connected to.

Order the necessary components separately from your local distributor.

## 2 Quick configuration using *TrikdisConfig* software

1. Download the configuration software *TrikdisConfig* from [www.trikdis.com](http://www.trikdis.com) (type “TrikdisConfig” in the search field) and install it.
2. Remove the lid of the **G17F** using a flat-head screwdriver as shown below:

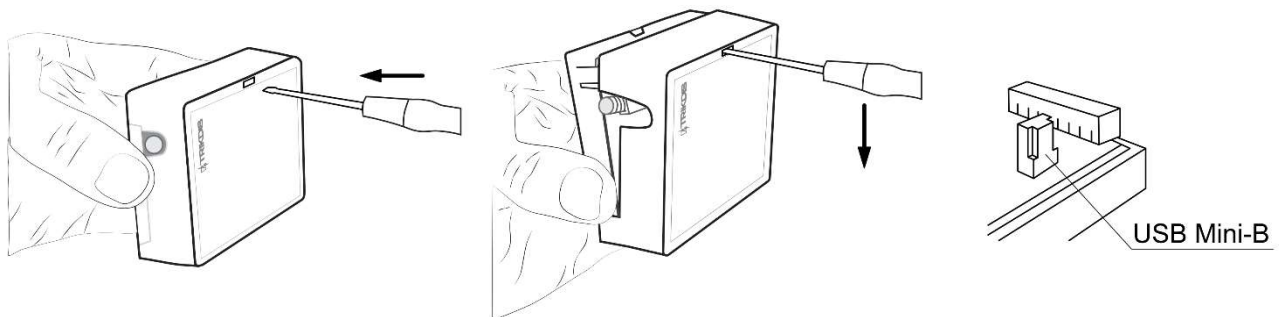

3. Connect the **G17F** to the computer using a USB Mini-B cable.
4. Launch *TrikdisConfig*. The program will automatically recognize the connected device and will automatically open the **G17F** configuration window.
5. Click the **Read [F4]** button to see the current parameters of the **G17F**. If a window requesting the administrator or installer code opens, enter the 6-digit code.

Below we describe the settings you need to edit to make the controller send events to the *Protegeus* app or to the Central Monitoring Station.



## 2.1 Settings for connecting to *Protegeus2* app

In the “Users & Reporting” window, “Cloud application” settings group:

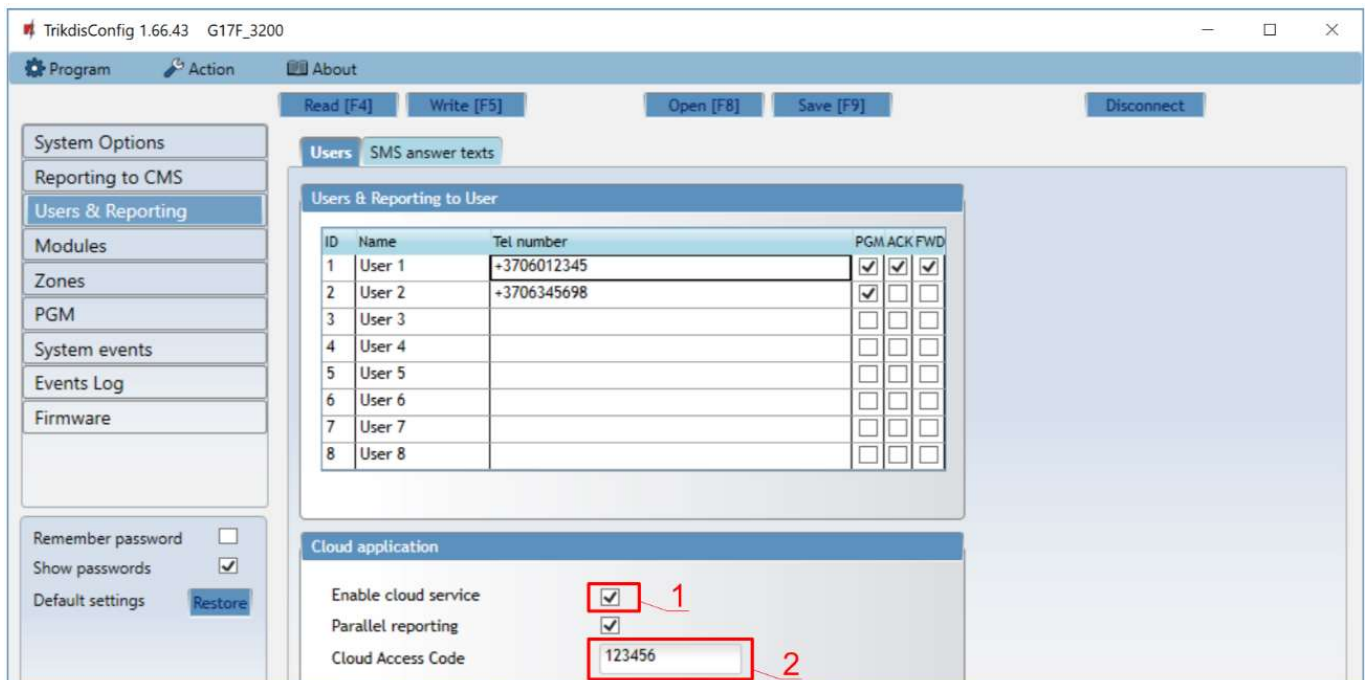

1. Tick the box **Enable cloud service**.
2. Change the **Protegeus Cloud access Code** if you want users to be asked to enter it when they add the system in the **Protegeus2** app (default password – 123456).

In the “System options” window, “SIM” settings group:

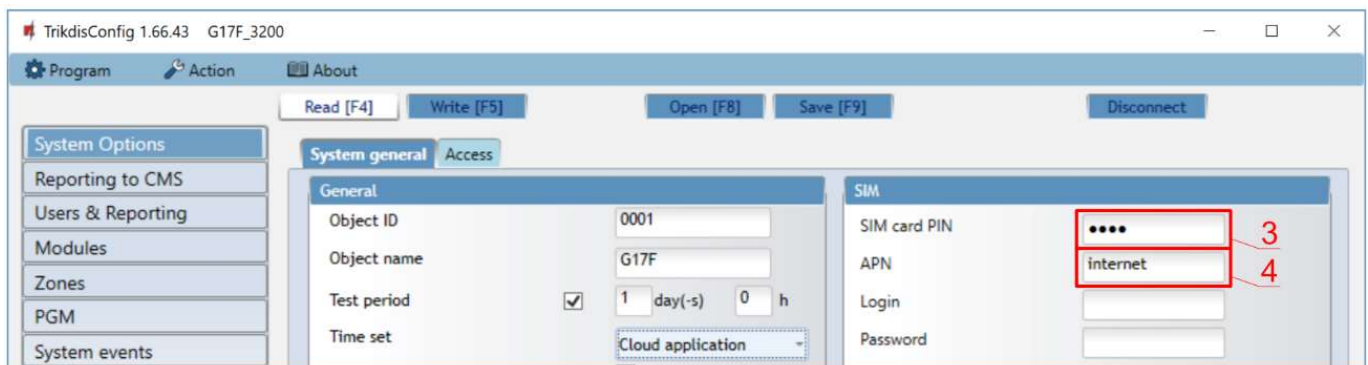

3. Enter the **SIM card PIN** code.
4. Change the **APN**. You will find the **APN** on the SIM operator’s website. “Internet” is universal and works in the networks of most operators.





## In the “Zones” window:

Zone No	Name	Input	Definition	Type	<input type="checkbox"/> CMS	<input checked="" type="checkbox"/> Prot.	Delay	CID Code	SIA E	SIA R	LOOP
1	Zone 1	G17F 1 IN	24_hours	NO	<input checked="" type="checkbox"/>	<input checked="" type="checkbox"/>	400	133	FA	FR	99
2	Zone 2	G17F 2 IN	24_hours	NO	<input checked="" type="checkbox"/>	<input checked="" type="checkbox"/>	400	133	FA	FR	99
3	Zone 3	G17F 3 I/O	24_hours	NO	<input checked="" type="checkbox"/>	<input checked="" type="checkbox"/>	400	133	FA	FR	99
4	Zone 4	G17F 4 I/O	24_hours	NO	<input checked="" type="checkbox"/>	<input checked="" type="checkbox"/>	400	133	FA	FR	99
5	Zone 5	Disable	24_hours	NO	<input checked="" type="checkbox"/>	<input checked="" type="checkbox"/>	400	133	FA	FR	99
6	Zone 6	G17F 6 IN	24_hours	NO	<input checked="" type="checkbox"/>	<input checked="" type="checkbox"/>	400	133	FA	FR	99

5. Tick the boxes if you want users to receive notifications to **Proteagus** about changes in zone states.

## In the “PGM” window:

PGM No	PGM output	Output definition	Pulse Time, s	<input type="checkbox"/> CMS	<input checked="" type="checkbox"/> Prot.	SIA E	SIA R
1	G17F 5 I/O	Remote Control	20	<input type="checkbox"/>	<input checked="" type="checkbox"/>	RC	RO
2	Disable	Remote Control	20	<input type="checkbox"/>	<input checked="" type="checkbox"/>	RC	RO
3	Disable	Remote Control	20	<input type="checkbox"/>	<input checked="" type="checkbox"/>	RC	RO

6. Tick the boxes if you want users to receive notifications to **Proteagus** about changes in PGM output states.

## In the “System events” window:

ID	Event name	<input type="checkbox"/> Enable	<input checked="" type="checkbox"/> CMS	<input checked="" type="checkbox"/> Prot.	CID Code	SIA E	SIA R	LOOP	SMS event text	SMS restore text
1	Low power	<input checked="" type="checkbox"/>	<input checked="" type="checkbox"/>	<input checked="" type="checkbox"/>	302	TY	RL	99	Low power	Power restore
2	Periodic test	<input checked="" type="checkbox"/>	<input checked="" type="checkbox"/>	<input checked="" type="checkbox"/>	602	PR	PP	99	Periodic test	
3	RS485 fault	<input checked="" type="checkbox"/>	<input checked="" type="checkbox"/>	<input checked="" type="checkbox"/>	333	TE	RR	99	RS485 device fault	RS485 device restore
4	GSM jamming	<input checked="" type="checkbox"/>	<input checked="" type="checkbox"/>	<input checked="" type="checkbox"/>	344	QX	HG	99	GSM jamming	NO GSM jamming
5	Start IP event	<input checked="" type="checkbox"/>	<input checked="" type="checkbox"/>	<input checked="" type="checkbox"/>	700	n/a	n/a	n/a		

7. Tick the boxes if you want users to receive notifications to **Proteagus** about changes in the communicator’s internal event states.

After finishing configuration, click the **Write [F5]** button and disconnect the USB cable.

**Note:** See chapter 5 “Description of TrikiDisConfig windows” to find more about other **G17F** settings in **TrikiDisConfig**.



## 2.2 Settings for connecting to Central Monitoring Station

In the “System Options” window:

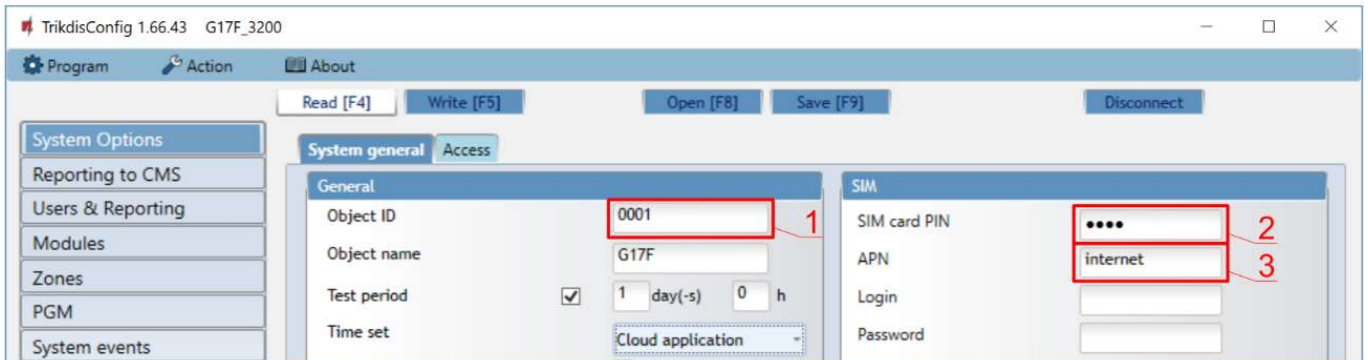

1. Enter the **Object ID** (account) number provided by the Central Monitoring Station (4 characters, 0-9, A-F. **Do not use FFEE, FFFF Object ID**).
2. Enter the **SIM card PIN** number.
3. Change the **APN**. You will find the **APN** on the SIM operator’s website. “Internet” is universal and works in the networks of most operators.

In the “Reporting to CMS” window:

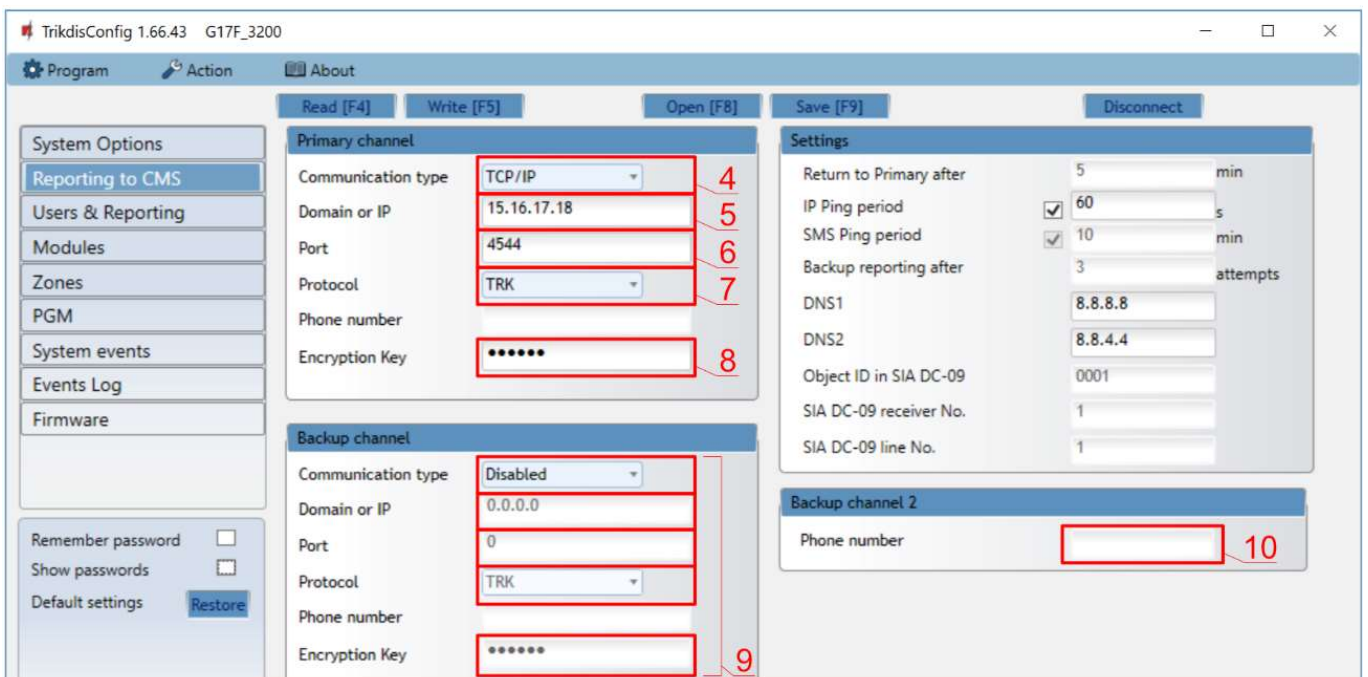

4. **Communication type** – choose a communication type (we do not recommend using SMS for the primary channel).
5. **Domain or IP** – enter the receiver’s domain or IP address.
6. **Port** – enter the receiver’s network port number.
7. **Protocol** – choose which transmission protocol should be used for sending messages: **TRK** (to TRIKDIS receivers), **DC-09\_2007** or **DC-09\_2012** (to universal receivers).
8. **Encryption Key** – enter the receiver’s encryption key.

**Note:** If you want to set connection to the Central Monitoring Station via **SMS** messages, you only need to set the **Encryption key** and **Phone number**. SMS messages can be received by TRIKDIS central monitoring station IP/SMS receiver RL14, multi-channel receiver RM14 and SMS receiver GM14.  
If you chose **DC-09** as the transmission protocol, additionally enter the object, line and receiver numbers in the **Settings** setting group of the “Reporting to CMS” window.



9. (Recommended) Configure the **Backup channel** settings.
10. (Recommended) Enter the **Backup channel 2** phone number.

After finishing configuration, click the **Write [F5]** button and disconnect the USB cable.

**Note:** See chapter 5 “Description of TrikdisConfig windows” to find more about other **G17F** settings in *TrikdisConfig*.

### 3 Wiring schematics, installation and turning on the system

#### 3.1 Fastening

1. Before installing the system, make sure that GSM signal strength is sufficient in the place where the **G17F** will be mounted.
2. Remove the top cover, pull out the contact terminal blocks.
3. Remove the board.
4. Fasten the base of the casing in the desired place using screws.
5. Reinsert the board and the contact terminal blocks.
6. Screw on the GSM antenna.
7. Insert a nano-SIM card. The SIM card must be registered to a GSM network and services must be enabled and functional, i.e. the card must be able to call, send and receive SMS messages, have enabled mobile data. Ask your SIM card’s mobile network operator how to enable desired services.

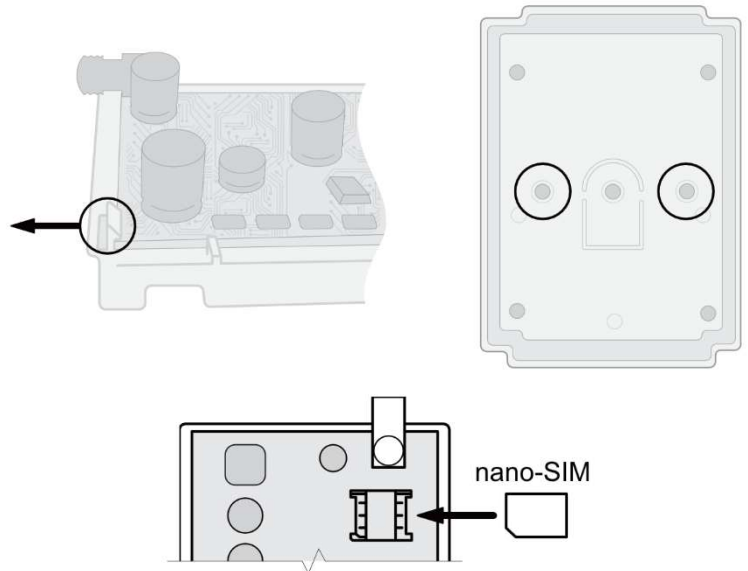

**Note:** Ensure that the SIM card is activated.  
Ensure that mobile data is enabled if you are going to use connection via IP channel.  
If you want to avoid entering the PIN code in *TrikdisConfig*, insert the SIM card into a phone and disable the PIN code request function.

8. To configure the **G17F** remotely, insert a SIM card with disabled PIN code requests. Turn on the communicator’s power supply. If the **G17F** was not configured using *TrikdisConfig* and *Protegeus* service was not enabled, send the SMS message: **CONNECT 123456 PROTEGUS=ON,APN=INTERNET**
9. Changing parameters remotely is detailed in chapter 6 “Setting parameters remotely”.
10. Reattach the top cover.



### 3.2 Schematic for connecting the communicator to a fire control panel

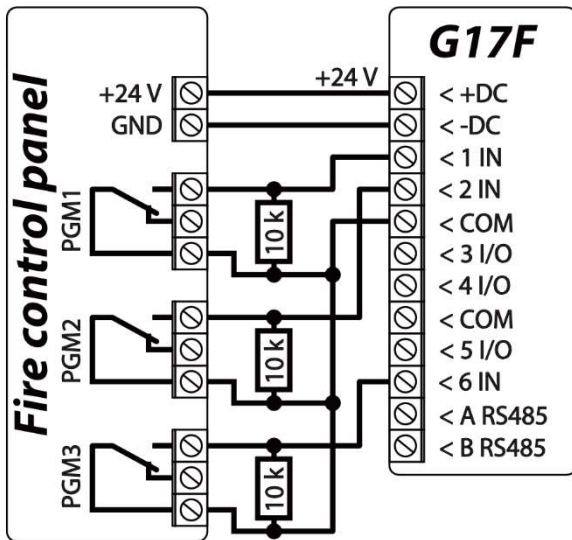

### 3.3 Schematic for connecting the communicator to an INIM Smartline fire control panel

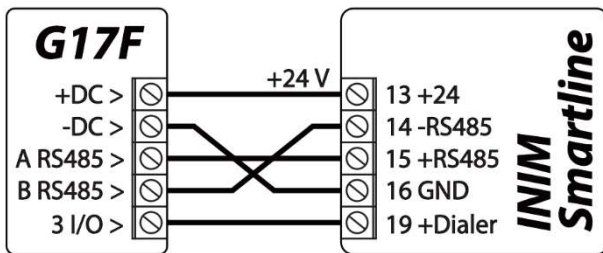

Slave mode must be set for the **INIM Smartline** panel when it is connected to the **G17F** communicator via RS485 bus.

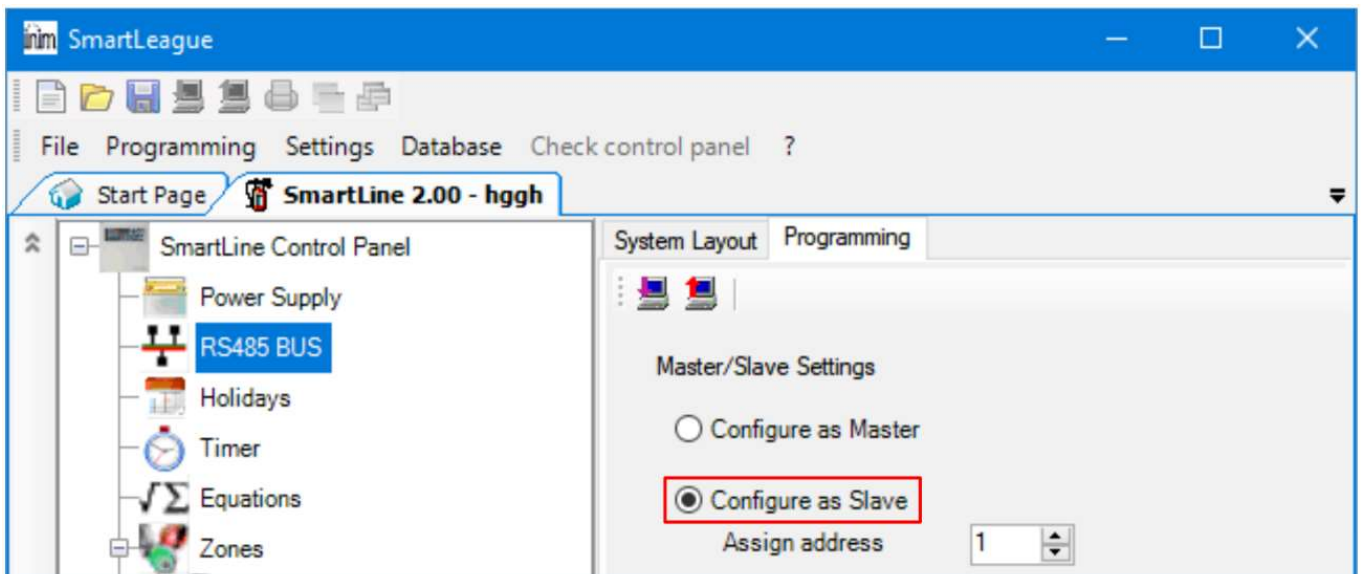

**Note:** You cannot connect the **G17F** using the RS485 bus if repeaters are connected to the **INIM Smartline** panel. iO expansion modules are not supported when the **G17F** is connected to the **INIM Smartline** panel via RS485 bus.



## 3.4 *TrikiDisConfig* settings when an INIM Smartline fire control panel is connected

In the “Modules” window:

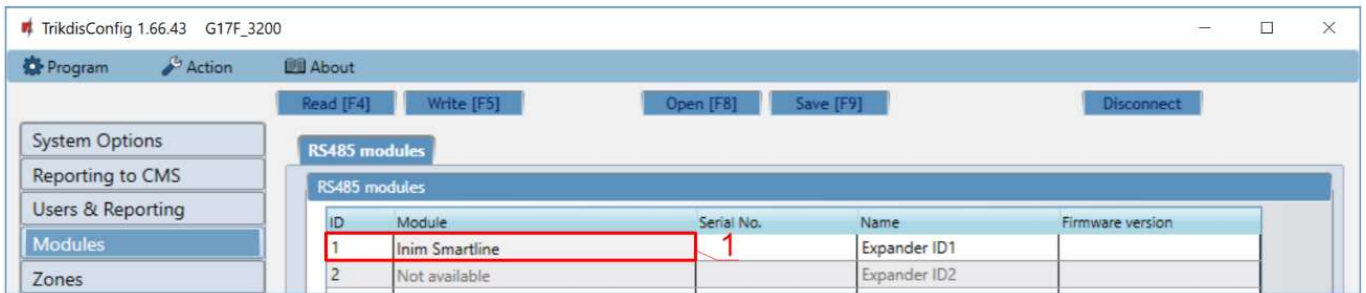

1. Choose the **Inim Smartline** module.

In the “PGM” window:

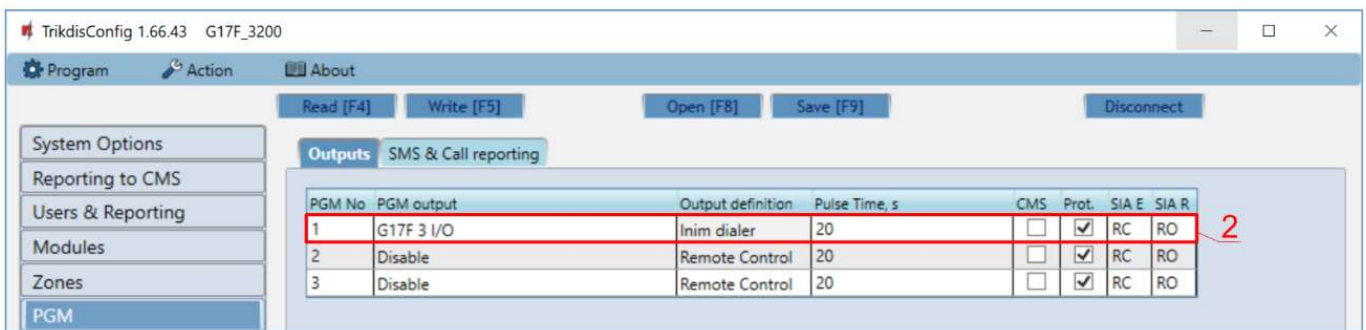

2. Specify the **G17F** communicator’s PGM output that is connected to the fire control panel’s 19<sup>th</sup> (+Dialer) terminal. Set **Output definition – Inim dialer**. (The PGM output is turned on when the **G17F** communicator has problems connecting to the CMS or is unable to send messages. The indicator **Disable/Fault Dialler** lights up on the fire control panel and a sound signal is turned on.).

In the “Users & Reporting” window:

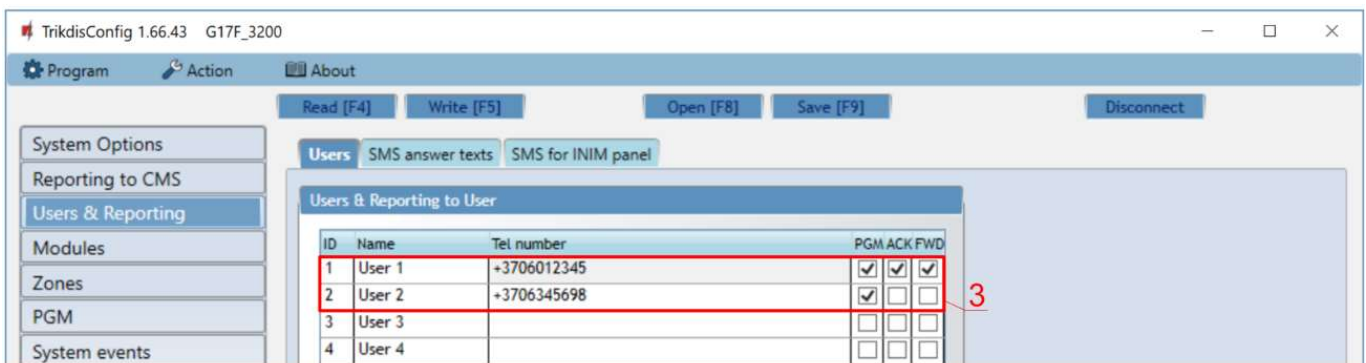

3. Enter phone numbers of users who should get messages from the **G17F** communicator.





## In the "SMS for Control panel" tab

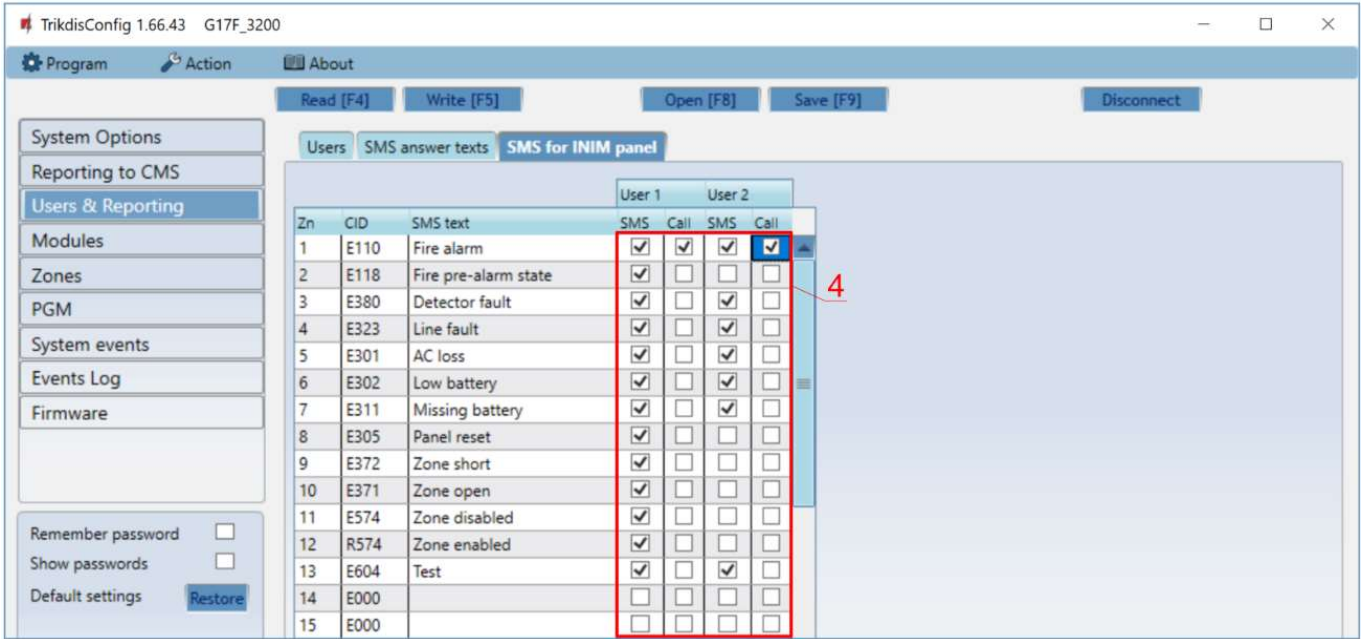

- Users will get SMS messages and phone calls about events that are ticked. You can add additional CID event codes in the **CID** column. You must enter **SMS text** messages next to new codes. If you want the user to receive messages (or calls) about events, tick the **SMS** (or **Call**) box.

## 3.5 Schematics for connecting inputs

The communicator has six (1IN – 6IN) input terminals (three terminals are dual purpose IN/OUT) for connecting NO, NC, EOL type circuits. Default input setting – monitor an EOL type circuit. You can set a different input type in the **TrikiDisConfig** window **Zones**.

Schematics of NO, NC, EOL type circuits:

Normally open (NO).  
Short - Alarm; Open - Restore.

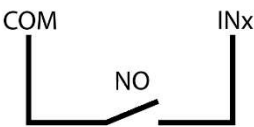

Normally closed (NC).  
Short - Restore; Open - Alarm.

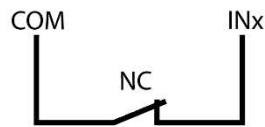

Normally open with 10k  
End of line resistor (EOL10k). Short - Alarm;  
Open - Alarm; 10k - Restore.

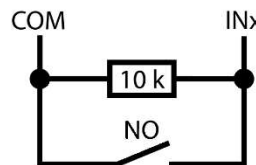

Normally closed with 10k  
End of line resistor (EOL10k). Short - Alarm;  
Open - Alarm; 10k - Restore.

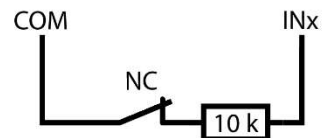



### 3.6 Schematic for connecting iO series expander modules

If the communicator needs more inputs IN or outputs OUT, connect a wired or wireless TRIKDIS iO series input and output expander.

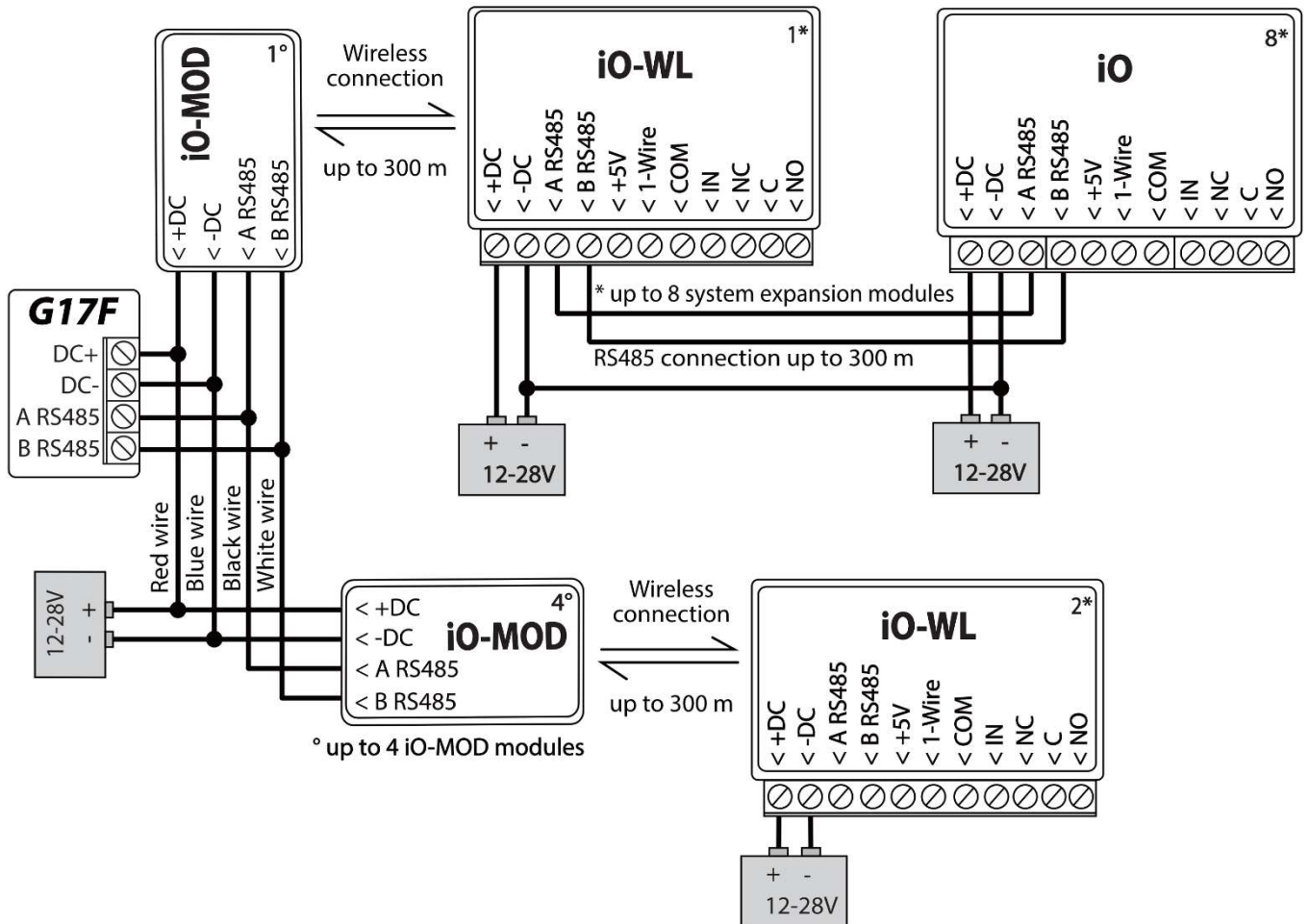

### 3.7 Schematic for connecting an iO-8 expander module

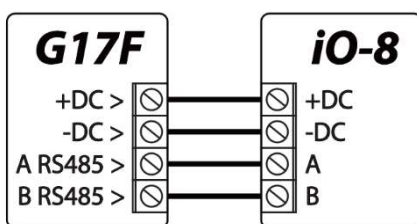



## 3.8 Schematic for connecting the W485 WiFi module

G17F firmware version from 1.08.

The **W485** module sends messages to the CMS (Central Monitoring Station) and to **Protegeus** using a WiFi internet router. When WiFi connectivity is available, the **G17F** sends event messages via the **W485** module. When WiFi connectivity is disrupted, the **G17F** sends messages via GPRS. When WiFi connectivity is re-established, the **G17F** returns to sending messages via **W485**.

Configuration of the **W485** WiFi module to work with the **G17F** is described in chapter 5.5. „„Modules” window”.

**You do not need a SIM card, when using the W485 with the G17F.**

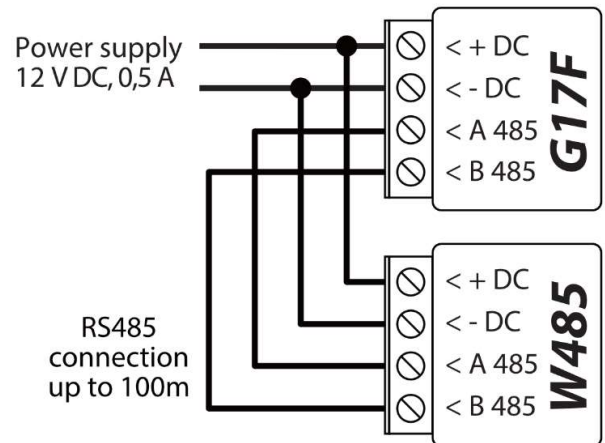

## 3.9 Schematic for connecting the E485 “Ethernet” module

G17F firmware version from 1.08 .

The **E485** sends messages to the CMS (Central Monitoring Station) and to **Protegeus** using a wired internet connection. Using the **E485** with **G17F**, CMS and **Protegeus** messages are sent over wired Internet and mobile Internet is not used. If a wired internet connectivity is disrupted, the **G17F** sends messages via the mobile Internet. When the wired Internet connectivity is re-established, **G17F** starts sending messages via **E485**.

Configuration of the **E485** module to work with the **G17F** is described in chapter 5.5. „„Modules” window”.

**You do not need a SIM card, when using the E485 with the G17F.**

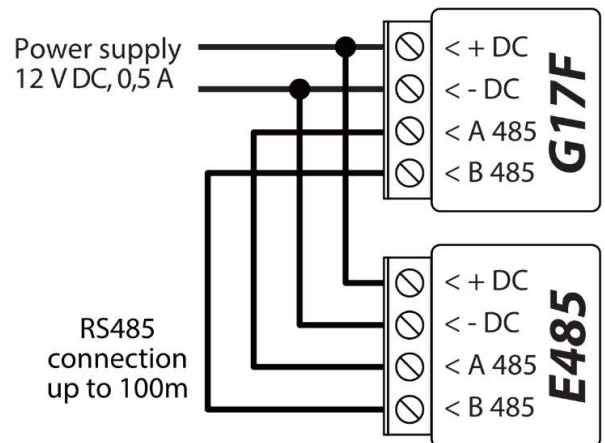

## 3.10 Turning on the communicator

To turn on the communicator, you must first provide a power source for the fire control panel. If the communicator is working properly, the following **G17F** indicator lights should turn on:

- The “POWER” diode must be green solid (sufficient power supply voltage);
- The “NETWORK” diode must be green solid and blink yellow when the communicator is connected to a network.

**Note:** Sufficient GSM signal level - 5 (five yellow flashes of the “NETWORK” indicator). Sufficient 4G signal level - 3 (three yellow flashes of the “NETWORK” indicator).  
If you count less than 3 yellow flashes of the “NETWORK” diode, the GSM signal level is insufficient. We recommend choosing a different place for installing the communicator or using a more sensitive GSM antenna.  
If the indication is different, search for the explanation in chapter 1.4 “LED indication of operation”.  
If the **G17F**'s indicator lights are completely inactive, check the power supply and connections.





## 4 Remote control

### 4.1 Adding the communicator to *Protegeus2* app

Using *Protegeus*, users can see the system’s state and receive notifications about system events.

1. Download and launch the *Protegeus2* app or use the browser version [www.protegeus.eu/login](http://www.protegeus.eu/login):



2. Create a new account or log in with your user name and password.

**IMPORTANT:** When adding the system to *Protegeus* the *G17F* communicator must:

1. Have an inserted and activated SIM card with the PIN code entered or disabled;
2. Have *Protegeus service* enabled. See 5.4 “Users & Reporting” window;
3. Have the power switched on (“POWER” LED must be green solid);
4. Be connected to a network (the “NETWORK” LED must be green solid and blink yellow).

3. Click „Add new system” and enter the *G17F*’s “Unique ID” number. It can be found on the device and packaging sticker. After entering the *unique ID*, click the “Next” button.

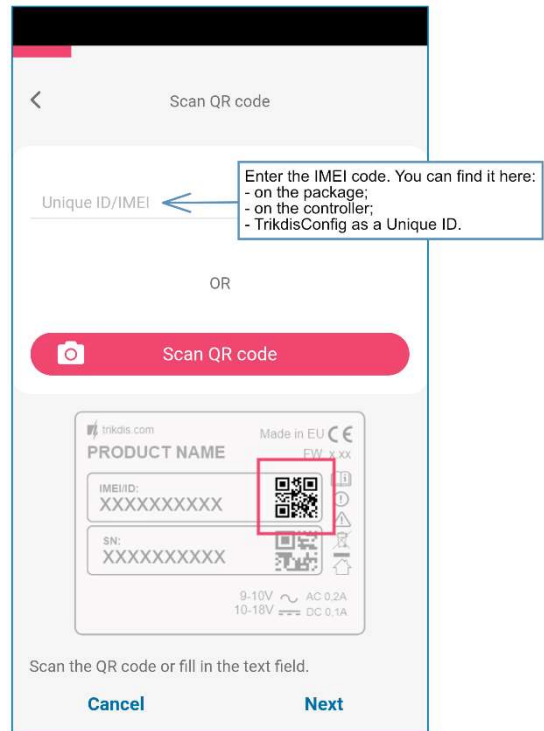

### 4.2 Configuration and control via SMS messages

#### 1. Change the administrator password

To ensure safety, change the default administrator SMS password. Send an SMS message of the following format:

**PSW 123456 xxxxxx**

- 123456**            Default administrator password
- xxxxxx**            New 6-symbol administrator password

#### 2. Allow other users to control

Only phone numbers on the user list can control the system using SMS messages or phone calls. From an administrator phone, send SMS messages with other people’s phone numbers and names to allow them to control the system:



## SETN xxxxxx PHONEx=+PHONENR#NAME

- xxxxxx**      6-symbol administrator password
- x**             User's number on the list. (If you write 1 as the user number, you will transfer your administrator's rights to the other user.)
- PHONENR**    User's phone number
- NAME**        User's name

### SMS command list

Command	Data	Description
<i>INFO</i>		Request information about the communicator. Communicator type, IMEI number, serial number and firmware version will be included in the answer. E.g.: <b>INFO 123456</b>
<i>RESET</i>		Reset the device. E.g.: <b>RESET 123456</b>
<i>OUTPUTx</i>	<i>ON</i>	Turn on an output, "x" is the output number. E.g.: <b>OUTPUT1 123456 ON</b>
	<i>OFF</i>	Turn off an output, "x" is the output number. E.g.: <b>OUTPUT1 123456 OFF</b>
	<i>PULSE=ttt</i>	Turn on an output for a few seconds - "x" is the OUT output number, and "ttt" is a three-digit number that specifies pulse time in seconds. E.g.: <b>OUTPUT1 123456 PULSE=002</b>
<i>PSW</i>	<i>New password</i>	Change password. E.g.: <b>PSW 123456 654123</b>
<i>TIME</i>	<i>YYYY/MM/DD,12:00:00</i>	Set date and time. E.g.: <b>TIME 123456 2019/01/09,12:23:00</b>
<i>TXTA</i>	<i>Object name</i>	Specify an object name. E.g.: <b>TXTA 123456 House</b>
<i>TXTE</i>	<i>Z1=&lt;Text&gt;</i> ..... <i>Z12=&lt;Text&gt;</i>	Customize zone alarm SMS message text: Z1...Z12 – input zone number. E.g.: <b>TXTE 123456 Z1=ALARM in Zone1</b>
<i>TXTR</i>	<i>Z1=&lt;Text&gt;</i> ..... <i>Z12=&lt;Text&gt;</i>	Customize zone restore SMS message text: Z1...Z12 – input zone number. E.g.: <b>TXTR 123456 Z1=Restore Zone1</b>
<i>RDR</i>	<i>PhoneNR#SMS text</i>	Forward SMS messages to the specified number. The phone number must start with a "+" sign and the international country code. E.g.: <b>RDR 123456 +37061234567#forwarded text</b>
<i>ASKI</i>		Request SMS message about statuses of inputs IN. E.g.: <b>ASKI 123456</b>
<i>ASKO</i>		Request SMS message about statuses of outputs OUT. E.g.: <b>ASKO 123456</b>
<i>SETN</i>	<i>PhoneX=PhoneNR#Name</i>	Add a phone number, username and assign it to user "x". "x" is the phone number's line on the list. The phone number must start with a "+" symbol and international country code. The phone number and username must be separated by a # symbol. E.g.: <b>SETN 123456 PHONE5=+37061234567#JOHN</b>
	<i>PhoneX=DEL</i>	Delete user's phone number and name from the system. E.g.: <b>SETN 123456 PHONE5=DEL</b>
<i>UUSD</i>	<i>*Usd code#</i>	Send a UUSD code to the operator. E.g.: <b>UUSD 123456 *245#</b>
<i>CONNECT</i>	<i>Protegeus=ON</i>	Connect to Protegeus cloud service. E.g.: <b>CONNECT 123456 PROTEGUS=ON</b>
	<i>Protegeus=OFF</i>	Disconnect from Protegeus cloud service. E.g.: <b>CONNECT 123456 PROTEGUS=OFF</b>
	<i>Code=123456</i>	Protegeus cloud service code. E.g.: <b>CONNECT 123456 CODE=123456</b>
	<i>IP=0.0.0.0:8000</i>	Specify the main server's connection channel's TCP IP and Port. E.g.: <b>CONNECT 123456 IP=0.0.0.0:8000</b>



Command	Data	Description
	<i>IP=0</i>	For turning off the main channel. E.g.: <b>CONNECT 123456 IP=0</b>
	<i>ENC=123456</i>	TRK encryption key. E.g.: <b>CONNECT 123456 ENC=123456</b>
	<i>APN=Internet</i>	APN name. E.g.: <b>CONNECT 123456 APN=INTERNET</b>
	<i>USER=user</i>	APN user. E.g.: <b>CONNECT 123456 USER=User</b>
	<i>PSW=password</i>	APN password. E.g.: <b>CONNECT 123456 PSW=Password</b>

## 4.3 Control PGM outputs using phone calls

**Note:** If no users have been added to the system, the first one to call the **G17F** will become the system administrator and will be the only one who can control the **G17F** using phone calls and SMS commands.  
If you want to allow additional users to control the system using phone calls, add them with **TrikdisConfig** or give them the rights using SMS commands.

Perform these actions if you want to control a PGM output remotely:

- The user must be allowed to control outputs OUT and the output OUT must have type “Remote control” assigned (using **TrikdisConfig**).
- Call the number of the **G17F**’s SIM card. The **G17F** will answer the call and you can dial commands using the phone’s keypad (see the table).

### Mobile phone keyboard command list

Keyboard buttons	Function	Description
<i>[output no]*[state no]#</i>	Control selected output OUT	Controls the specified PGM output. State: <i>[0]</i> – output turned off; <i>[1]</i> – output turned on; <i>[2]</i> – turned off for pulse time; <i>[3]</i> – turned on for pulse time; (pulse time is specified in the <b>TrikdisConfig</b> software, “PGM” table) <i>[*]</i> – this symbol shows the end of the command. E.g. (turn on output 1): <b>1*1#</b> E.g. (turn off output 1): <b>1*0#</b> E.g. (turn on output 2 for <b>Pulse time</b> specified in the <b>TrikdisConfig</b> “PGM” table): <b>2*3#</b>
#	Retry entering the command	If you made a mistake while entering the command, press # on the phone’s keyboard and enter the command again.

## 5 Description of **TrikdisConfig** windows

### 5.1 Description of **TrikdisConfig** status bar

Once the **G17F** is connected, **TrikdisConfig** will display information about the connected device in its status bar.

IMEI/Unique ID: 862261044865843							
Status: Ready	Device: G17F_3200	SN: 000002	BL: 2.03	FW: 1.12	HW:	State USB	Role: Administrator



Name	Description
IMEI/Unique ID	Device's IMEI number
Status	Operational state
Device	Device type (must show <b>G17F</b> )
SN	Device's serial number
BL	Bootloader version
FW	Device's firmware version
HW	Device's hardware version
State	Type of connection with the program (USB or remote)
Role	Access level (shown after access code is approved)

When the **Read [F4]** button is clicked, the program will read and show settings currently saved on the **G17F**. With **TrikiDisConfig**, set the required parameters using the following program window descriptions.

## 5.2 "System Options" window

### "System general" tab

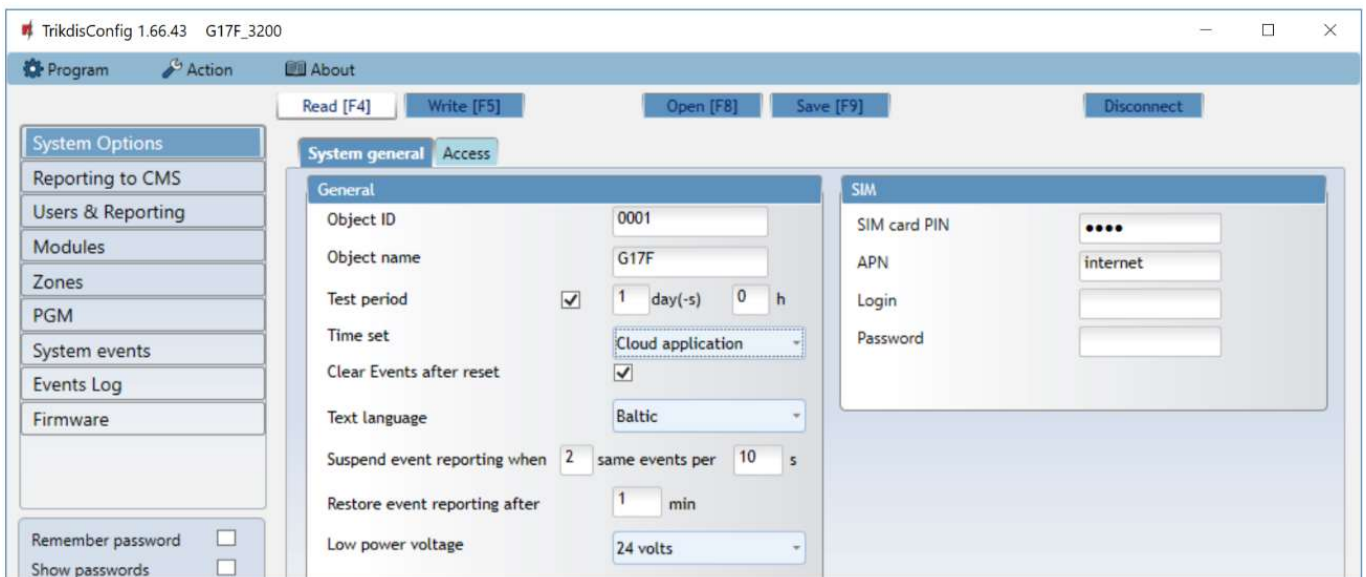

### "General" settings group

- **Object ID** – if events are going to be sent to the CMS, enter the Object ID (4-symbol hexadecimal number, 0-9, A-F. **Do not use FFFE, FFFF Object ID**) given by the CMS.
- **Object name** – the name given to the object that will be used in SMS messages sent to the user.
- **Test period** - when the box is ticked, "Test" messages will be sent every set period.
- **Time set** – choose a server to synchronize time with. If you choose "IP server", time will be synchronized with the IP receiver's time, if you choose "GSM modem", time will be synchronized with the GSM service provider's server time.
- **Clear Events after reset** – all unsent event messages will be deleted upon reset.
- **Text language** – set the preferred language and the specific symbols of that language will be used in SMS messages.
- You can **Suspend event reporting when ...** a number of **same events per ... s** happen.
- **Restore event reporting after ...** – set the time after which suspending of event reporting will be cancelled. The time can be anywhere from 0 to 999 minutes.
- **Low power voltage** – specify the power supply voltage (12 V or 24 V) that will be used for forming messages about insufficient power supply voltage.



## “SIM” settings group

- Enter the **SIM card PIN** code.
- **APN** – network service provider’s mobile internet access point name. You must enter the APN if event messages will have to be sent to **Protegeus** app or to the CMS via GPRS.
- If required by the GPRS network service provider, enter the APN user name and password in the fields **Login** and **Password**.

## “Access” tab

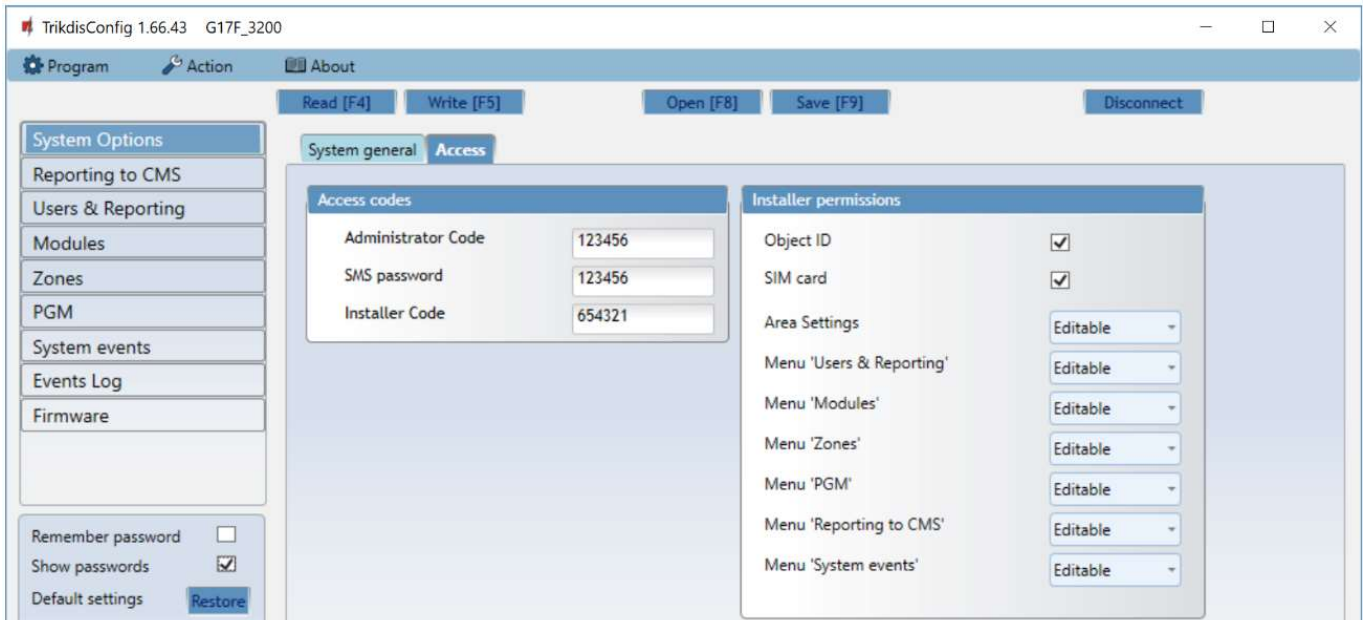

## Settings group “Access codes”

- **Administrator Code** – gives full access to configuration functions (default code – 123456).
- **SMS password** – password for remote control and programming via SMS messages (default code – 123456).
- **Installer Code** – gives limited access to changing the communicator’s configuration (default code – 654321).

## Settings group “Installer permissions”

The administrator can set which parameters can be changed by the installer.



## 5.3 “Reporting to CMS” window

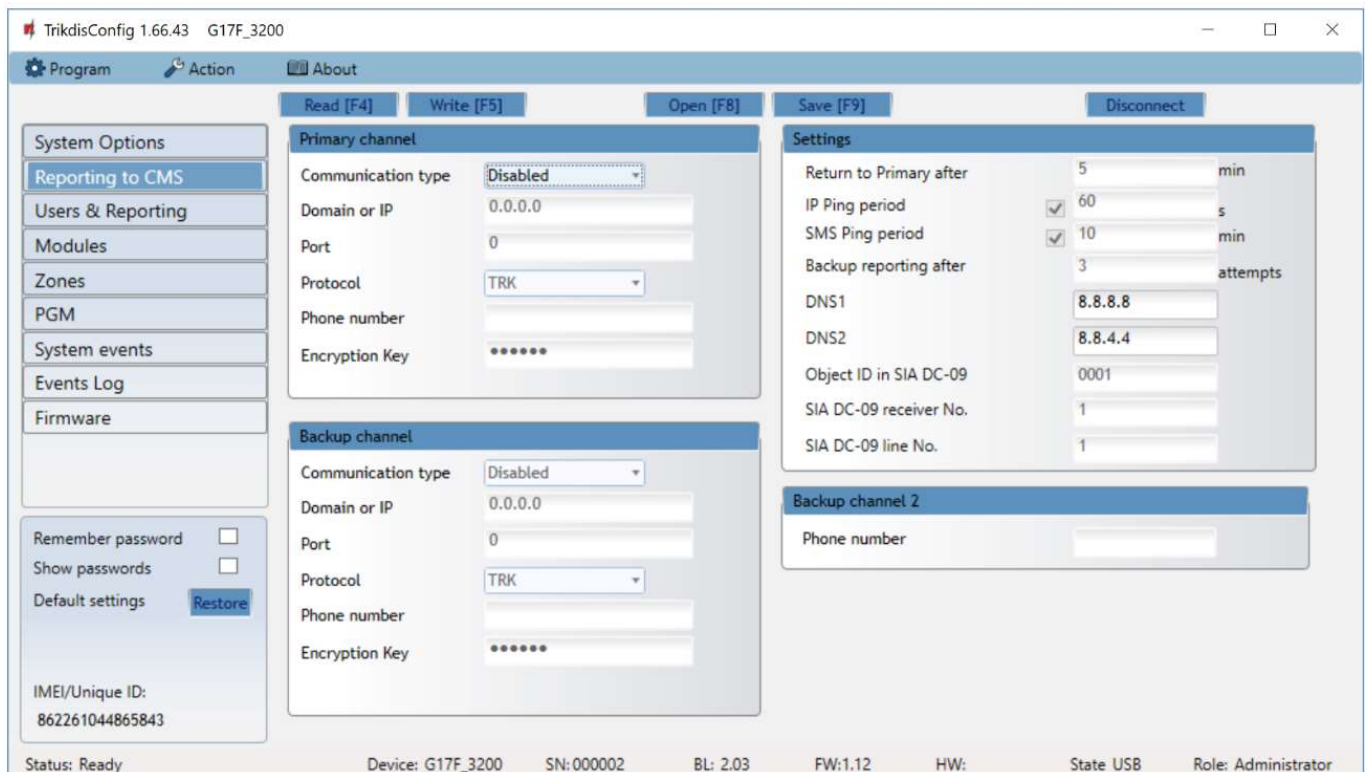

The communicator sends messages to the Central Monitoring Station using internet (IP) or SMS messages.

You can assign a backup channel to the primary channel. It will be used when connection via the primary channel is lost.

Messages sent to the Central Monitoring Station are encoded and password protected. To receive messages and forward them to monitoring software, a TRIKDIS receiver is required:

- For IP messages – receiving program IPcom Windows/Linux, hardware IP/SMS receiver RL14 or multi-channel receiver RM14.
- For SMS messages – hardware IP/SMS receiver RL14, multi-channel receiver RM14 or SMS receiver GM14.

Connection via SMS messages is extremely useful for the backup channel, because it works even when internet connectivity in the operator’s network is disrupted. Using SMS as the primary channel is not recommended.

### Settings group “Primary channel”

- **Communication type** – choose a method for connecting to the Central Monitoring Station’s receiver.
- **Domain or IP** – enter the receiver’s domain or IP address.
- **Port** – enter the receiver’s network port number.
- **Protocol** – TRIKDIS IP receivers can receive messages sent in the **TRK** protocol, and **SIA DC-09** protocols are used for IP receivers capable of receiving event messages sent in SIA DC-09 protocols.
- **Phone number** – (only for SMS messages) enter the phone number of a TRIKDIS SMS receiver. The phone number must start with the country code (e.g.: 370xxxxxxx).
- **Encryption Key** – 6-digit message encryption key. The communicator’s encryption key must match the receiver’s encryption key.

### Settings group “Backup channel”

Enable backup channel mode to allow messages to be sent using the backup channel if the connectivity is disrupted. Configure the backup channel using the same settings as described above.

### Settings group “Settings”

- **Return to Primary after** – time period after which the **G17F** will attempt to regain connection with the Primary channel.
- **IP PING period** – sending period of internal PING signals for checking connectivity. These messages are sent only via IP channel. The receiver does not forward these signals to the monitoring software and thus does not overload the





software. The monitoring software is only notified when the receiver does not receive a PING message from the device for a preset period of time.

By default, the receiver will send a “*Connection lost*” message to the monitoring software after a time period that is three times longer than the communicator’s PING sending period. E.g. if the IP PING period is 3 minutes, the receiver will send a lost connection message if it does not receive a PING for 9 minutes.

PING messages also keep an active connection session between the device and the receiver. An active session is required to configure and control the communicator remotely. We recommend setting the PING period to be no longer than 5 minutes.

- **SMS Ping reporting** - period of sending a PING signal over the channel for sending SMS messages, min.. Check the box to enable communication channel and specify the time interval.
- **Backup reporting after** – specify the number of unsuccessful attempts to send a message using the **Primary channel**. If the message fails to send after the specified number of attempts, the device will transmit using the **Backup channel**.
- **DNS1, DNS2** – (Domain Name System) server that specifies the domain IP address. It is used when a domain is specified in the connectivity channel’s **Domain or IP** field (instead of an IP address). Default setting - Google DNS server addresses.

The following settings are only shown when **DC-09\_2007** or **DC-09\_2012** protocol is chosen in the connectivity channel’s **Protocol** field.

- **Object ID in SIA DC-09** – enter the object number. If you chose the DC-09 protocol, the object number entered in this field will be used. You can enter the 3-16 symbol hexadecimal number given by the central monitoring station.
- **SIA DC-09 receiver No.** – enter the receiver’s number.
- **SIA DC-09 line No.** – enter the line number in the receiver.

## Settings group “Backup channel 2”

- **Phone number** - (only for SMS messages) enter the phone number of a TRIKDIS SMS receiver. The phone number must start with the country code (e.g.: 370xxxxxxx).

## 5.4 “Users & Reporting” window

### “Users” tab

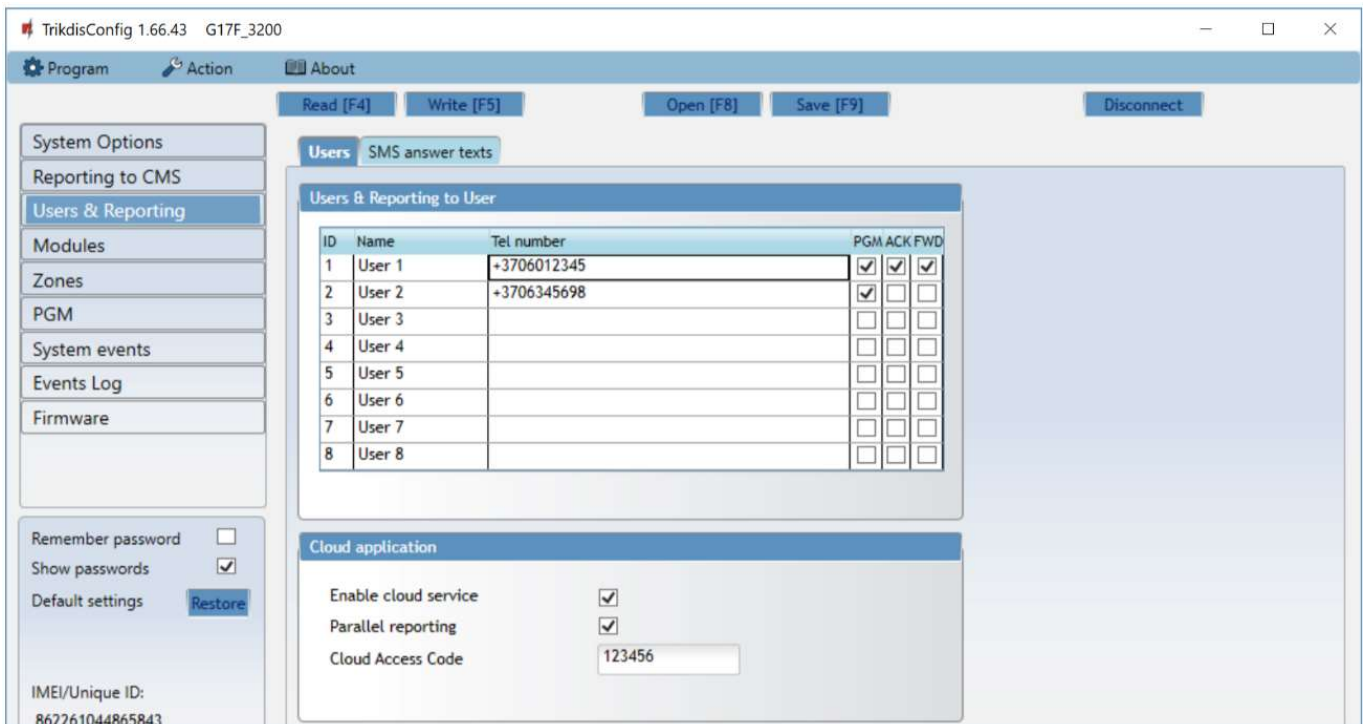

### Settings group “Users & Reporting to User”

- **ID** – user’s number on the list.
- **Name** – user’s name. These names will be used in event SMS messages.



- **Tel number** – the user’s phone number that will receive SMS messages. Numbers must be entered with the international code.
- **PGM** – if the box is ticked, the user can remotely control outputs.
- **ACK** – if the box is ticked, the **G17F** will send SMS messages with **SMS answer text** to the user after every received SMS command.
- **FWD** – if the box is ticked, SMS messages received from non-system users will be forwarded to the user (e.g. SIM card account balance, random promotional messages, etc.).

## Settings group “Cloud application”

- **Enable cloud service** – enable **Protegun** service to allow the **G17F** to exchange data with the **Protegun** app and remotely configure the device using **TrikdisConfig**.
- **Parallel reporting** – enable parallel message sending via the **Primary channel** and to **Protegun**.
- **Cloud access code** – 6-digit code for logging in to **Protegun** (default code - 123456).

## “SMS answer texts” tab

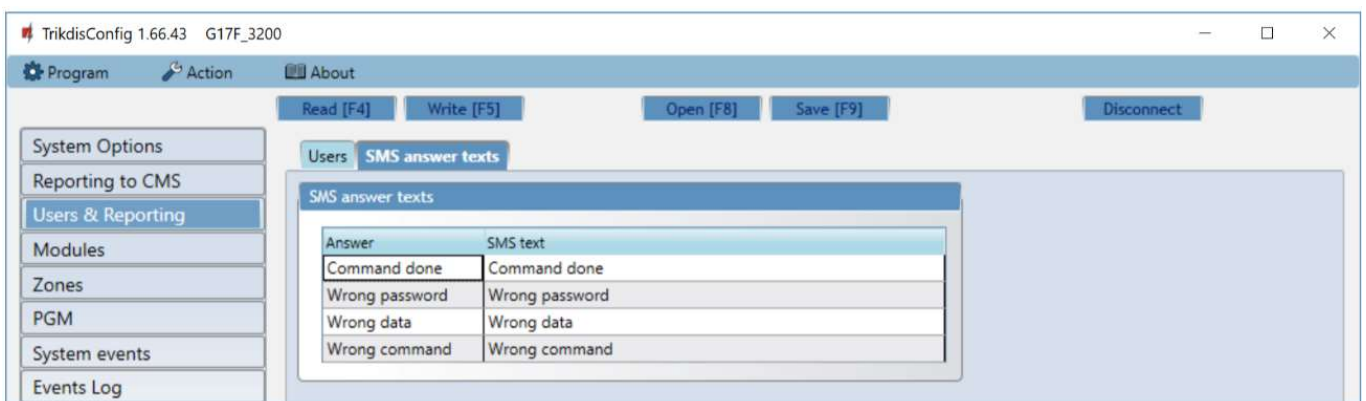

## Settings group “SMS answer texts”

- Edit the answer texts to control commands sent via SMS messages in the column **SMS text**.

## “SMS for INIM panel” tab

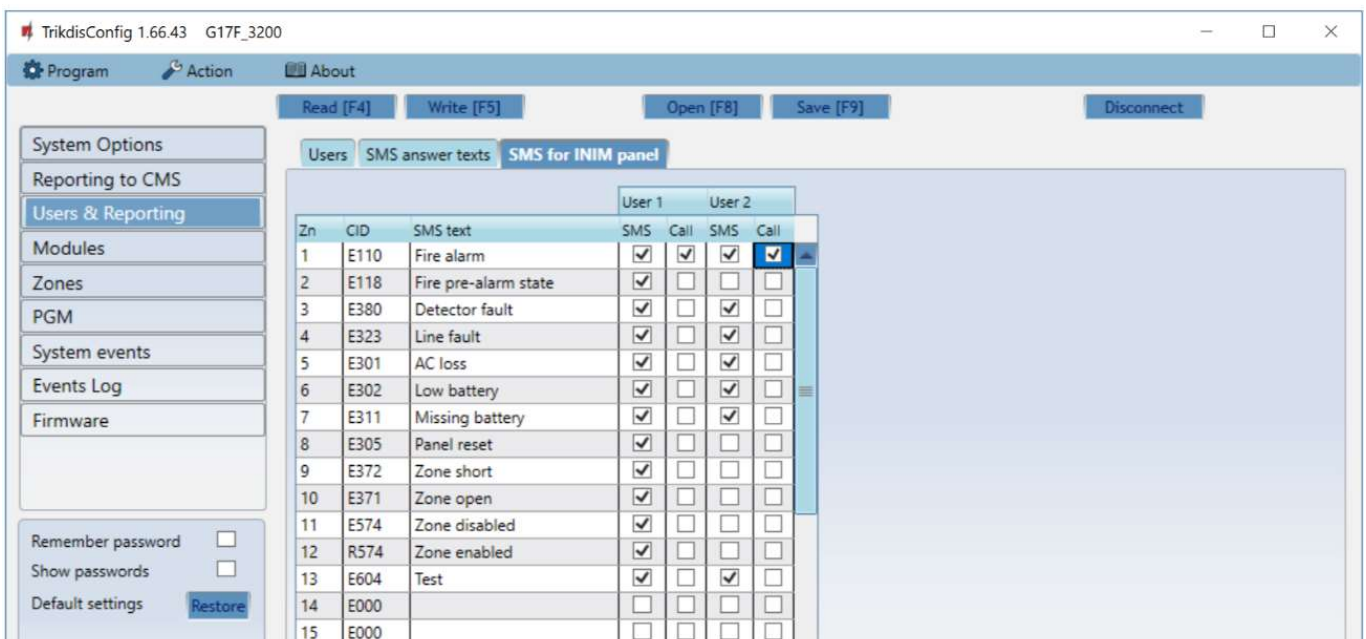

- **Zn** – event’s number on the list.
- **CID** – event’s Contact ID code.
- **SMS text** – event’s SMS message text.





- **User SMS/Call**– choose how to inform users about every event – SMS message and/or call.

## 5.5 “Modules” window

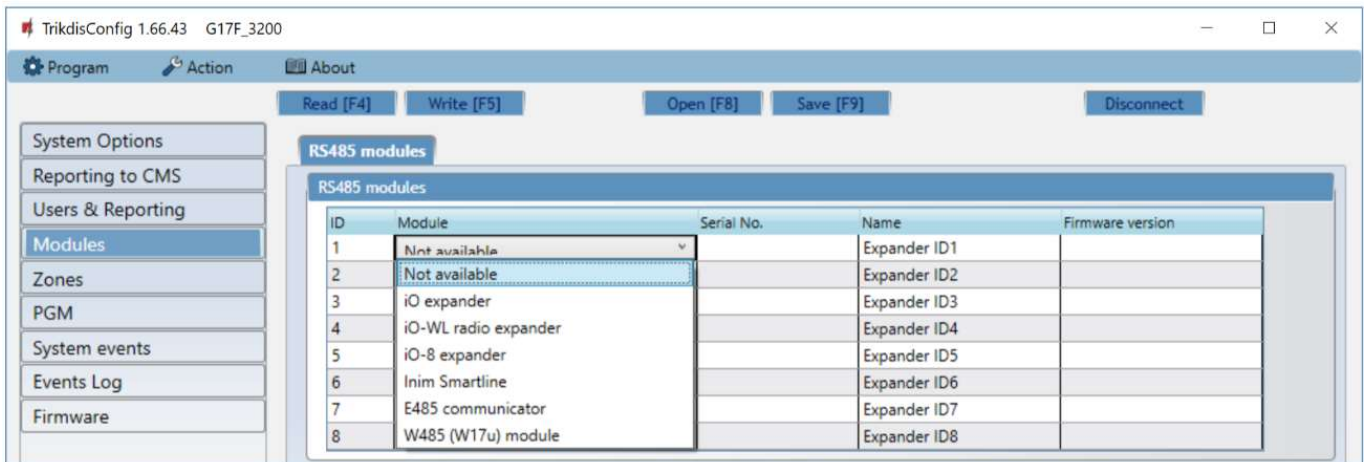

### Settings group “RS485 modules”

- **ID** – module’s number on the list.
- **Module** – choose the module being used (modules *iO*, *iO-WL*, *iO-8*, *Inim Smartline*, *E485*, *W485*) from the module list.
- **Serial No.** – mandatory 6-digit number that can be found on the module’s casing and its packaging.
- **Name** – you can give the module a name.
- **Firmware version** – the firmware version will be shown when the **G17F** finds the connected module.

### „W485 settings“ tab

#### WiFi module W485 (W17u) settings window

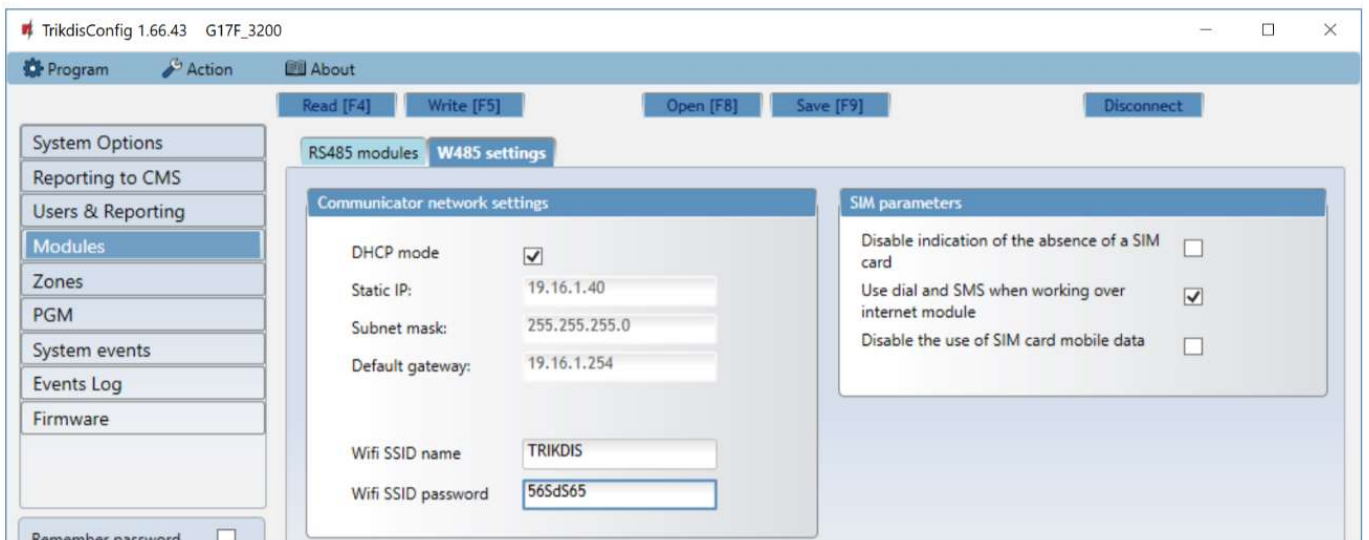

### „Communicator network settings“ settings group

- **DHCP mode** – WiFi module’s mode for registering to network (manual or automatic). Check the box (automatic registration mode) and the WiFi module will automatically scan the network settings (subnet mask, gateway) and will be assigned an IP address.
- **Static IP** – static IP address for when manual registering mode is set.
- **Subnet mask** – subnet mask for when manual registering mode is set.
- **Default gateway** – gateway address for when manual registering mode is set.
- **Wifi SSID name** – name of the WiFi network that the **W485 (W17u)** will connect to.
- **Wifi SSID password** - WiFi network password.



### „SIM parameters“ settings group

- **Disable indication of the absence of a SIM card** – checking the box will disable the indication of the absence of the SIM card in the **G17F** controller.
- **Use dial and SMS when working over internet module** – checking the box will enable control of the communicator via call and SMS. If the field is not checked and there is a Wi-Fi network, then the call and SMS messages are not used. If the field is unchecked and there is no Wi-Fi network, then **G17F** can manage call and SMS messages. **G17F** will send SMS messages to the user.
- **Disable the use of SIM card mobile data** – checking the box will disable the use of mobile data from the SIM card. Data will only be sent via module **W485**. If the Wi-Fi network is disconnected, **G17F** will store data in memory. After restoring the Wi-Fi network, the **G17F** will send the saved data via the Wi-Fi **W485** module.

### „E485 settings“ tab

### „Ethernet“ module E485 settings windows



### „Communicator network settings“ settings group

- **DHCP mode** – „Ethernet“ module’s mode for registering to network (manual or automatic).
- **Static IP** – static IP address for when manual registering mode is set.
- **Subnet mask** – subnet mask for when manual registering mode is set.
- **Default gateway** – gateway address for when manual registering mode is set.

### „SIM parameters“ settings group

- **Disable indication of the absence of a SIM card** – checking the box will disable the indication of the absence of the SIM card in the **G17F** controller.
- **Use dial and SMS when working over internet module** – checking the box will enable control of the communicator via call and SMS. If the field is unchecked and there is internet, then SMS and calls are not used. If the field is unchecked and there is no Internet, then **G17F** can manage call and SMS messages. **G17F** will send SMS messages to the user.
- **Disable the use of SIM card mobile data** – checking the box will disable the use of mobile data from the SIM card. Data will only be sent via module **E485**. If the internet disappears, **G17F** will store data in memory. When the Internet is restored, the **G17F** will send the saved data via the “Ethernet” **E485** module.



## 5.6 “Zones” window

### “Zones settings” tab

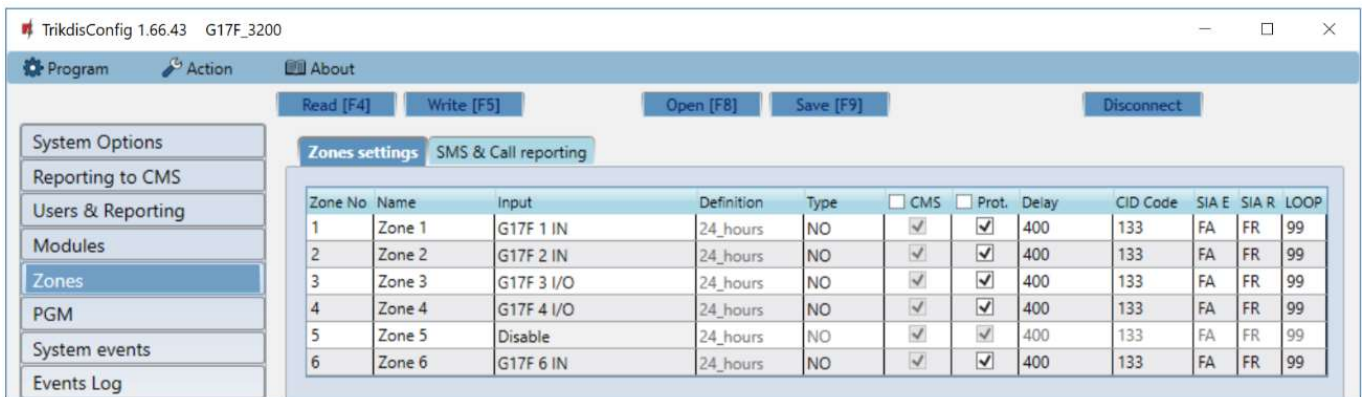

- **Zone No** – zone’s number on the list.
- **Name** - the zone can be given a name that will be used in SMS messages.
- **Input** – choose which **G17F** or expansion module input IN to assign to a zone.
- **Definition** – all zones are assigned the **24 hours** definition. If this zone is violated, a message about the event is sent immediately.
- **Type** – choose the type of circuit connected to the zone input IN from a list: NC – normally closed contact, NO – normally open contact, EOL – with a 10 kΩ resistor at the end of the circuit.
- **CMS** – if the box is ticked, messages about zone events will be sent to the CMS (central monitoring station).
- **Prot.** – if the box is ticked, notifications about zone events will be sent to **Protegeus** app.
- **Delay** – IN input zone reaction time in milliseconds.
- **CID Code** – event’s Contact ID code.
- **SIA E** – SIA Event code.
- **SIA R** – SIA Restore code.
- **LOOP** - the loop number is indicated in the SMS message.

### “SMS & Call reporting” tab

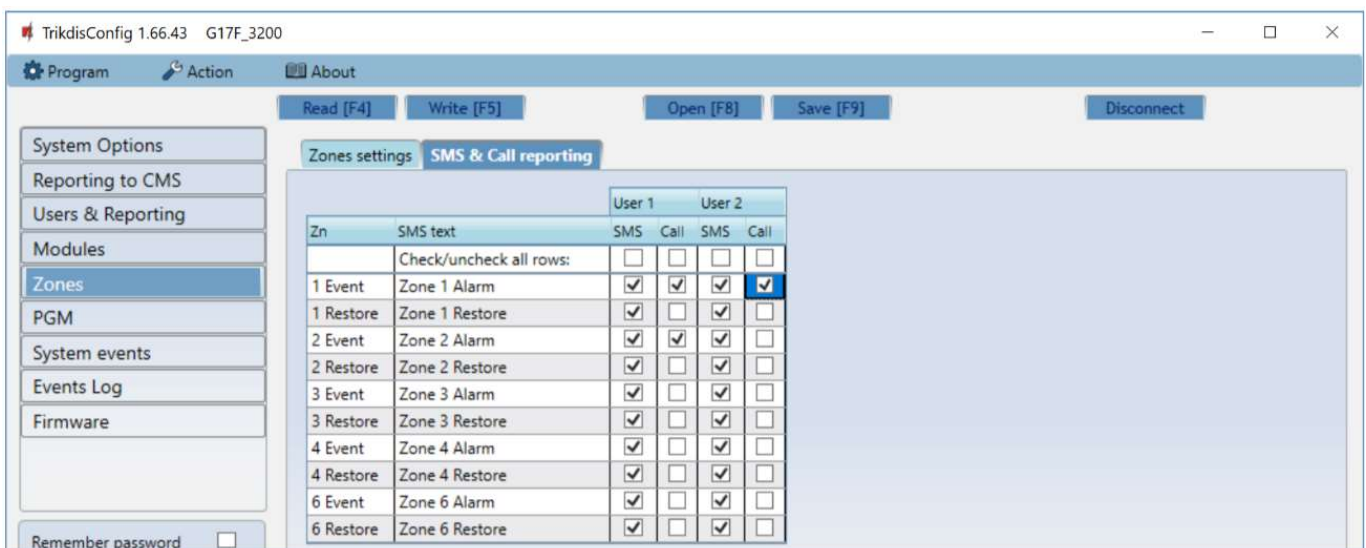

This window will only be shown if there is at least one User added in the “Users & Reporting” window.

- **Zn** – zone number with an event identification word. Can be “Event” or “Restore”.
- **SMS text** – description of the zone event that will be included in SMS event messages sent to users.
- **User SMS/Call** – choose how to inform users about every zone event – via SMS message and/or call.



## 5.7 “PGM” window

### “Outputs” tab

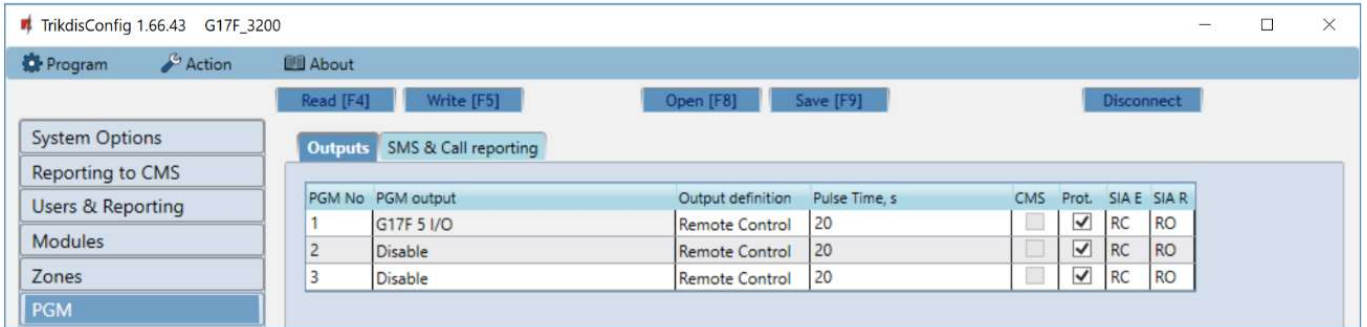

- **PGM No** – PGM output’s number on the list.
- **PGM output** – assign outputs OUT of the **G17F** or of an external device to a PGM.
- **Output definition** – select operational mode of an output OUT.
- **Pulse time, s** – assign a desired OUT turn on duration from 0 to 9999 seconds.
- **CMS** – if the box is ticked, messages about chosen events will be sent to CMS.
- **Prot.** – if the box is ticked, output event notifications will be sent to **Protegeus** app.
- **SIA E** – SIA Event code.
- **SIA R** – SIA Restore code.

### “SMS & Call reporting” tab



- **PGM** – the number of output OUT and turn on/off event type (“Event” – output OUT turn on event and “Restore” – OUT turn off event).
- **SMS text** – output OUT turn on/off event name that will be included in the event’s SMS message.
- **User SMS/Call** – choose which users to inform via SMS message and/or call when an output OUT is turned on/off.

## 5.8 “System events” window

### “Events” tab

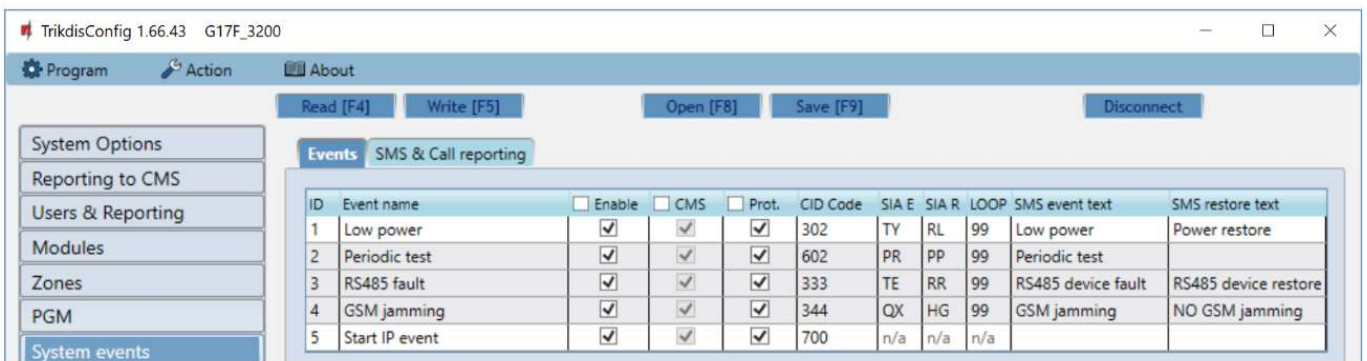





- **ID** – event’s number on the list.
- **Event name** – event name.
- **Enable** – enable event recognition.
- **CMS** – messages about chosen events will be sent to CMS.
- **Prot.** – notifications about chosen events will be sent to *Protegeus* app.
- **CID Code** – event’s Contact ID code.
- **SAI E** – SIA Event code.
- **SIA R** – SIA Restore code.
- **LOOP** - the loop number is indicated in the SMS message.
- **SMS event text** – text of the event’s SMS message.
- **SMS restore text** - text of the event’s restore SMS message.

## “SMS & Call reporting” tab

ID	Event SMS text	User 1		User 2	
		SMS	Call	SMS	Call
	Check/uncheck all rows:	<input type="checkbox"/>	<input type="checkbox"/>	<input type="checkbox"/>	<input type="checkbox"/>
1 Event	Low power	<input checked="" type="checkbox"/>	<input type="checkbox"/>	<input checked="" type="checkbox"/>	<input type="checkbox"/>
1 Restore	Power restore	<input checked="" type="checkbox"/>	<input type="checkbox"/>	<input checked="" type="checkbox"/>	<input type="checkbox"/>
2 Event	Periodic test	<input checked="" type="checkbox"/>	<input type="checkbox"/>	<input checked="" type="checkbox"/>	<input type="checkbox"/>
3 Event	RS485 device fault	<input checked="" type="checkbox"/>	<input type="checkbox"/>	<input checked="" type="checkbox"/>	<input type="checkbox"/>
3 Restore	RS485 device restore	<input checked="" type="checkbox"/>	<input type="checkbox"/>	<input checked="" type="checkbox"/>	<input type="checkbox"/>
4 Event	GSM jamming	<input checked="" type="checkbox"/>	<input type="checkbox"/>	<input checked="" type="checkbox"/>	<input type="checkbox"/>
4 Restore	NO GSM jamming	<input checked="" type="checkbox"/>	<input type="checkbox"/>	<input checked="" type="checkbox"/>	<input type="checkbox"/>

- **ID** – event’s number on the list and identification word (*Event, Restore*).
- **Event SMS text** – text that will be included in SMS messages about events.
- **User SMS/Call** – choose how to inform users about every event – via SMS message and/or call.

## 5.9 “Events Log” window

Event No.	Time	CID	Event definition
60	2016-03-01 00:00:00	302:99:000	Low Battery
59	2016-03-01 00:00:00	305:00:001	System start
58	2016-03-01 00:00:00	302:99:000	Low Battery
57	2016-03-01 00:00:00	305:00:016	System start
56	2016-03-01 00:00:00	302:99:000	Low Battery
55	2016-03-01 00:00:00	305:00:016	System start
54	2016-03-01 00:00:00	302:99:000	Low Battery
53	2016-03-01 00:00:00	305:00:016	System start

- **Read Log** button – for reading the event log from the device’s memory.
- **Clear Log** button – for clearing the event log entries from the device’s memory.
- In the table, you can find the **Event No.**, **Time**, **CID** code, **Event definition**. The events log can show up to 1000 events stored in the *G17F*’s memory.



## 5.10 Restore default settings

To restore the communicator’s default settings, click the **TrikdisConfig** button **Restore**.

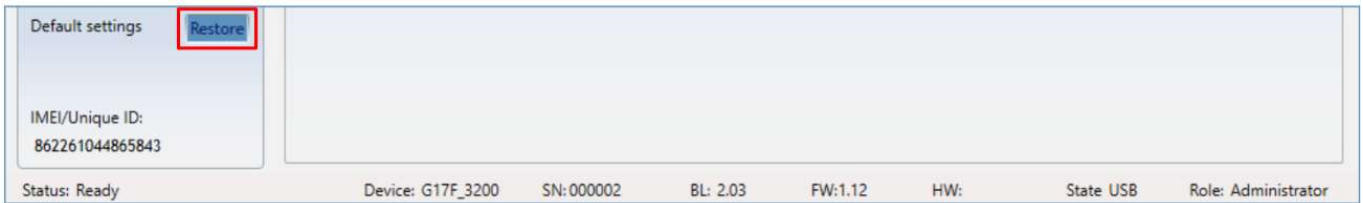

## 6 Setting parameters remotely

**IMPORTANT:** Remote configuration will only work when the **G17F**:

1. Has an inserted and activated SIM card with the PIN code entered or disabled.
2. Has **Protegeus service** enabled. See 5.4 “Users & Reporting” window.
3. Has the power switched on (“POWER” LED must be green solid);
4. Is connected to a network (the “NETWORK” LED must be green solid and blink yellow).

If NETWORK is yellow solid or DATA is yellow solid, the device cannot connect to GSM and/or **Protegeus**.

1. On your computer, launch the configuration software **TrikdisConfig**.
2. In the **Remote access** window, enter the communicator’s **Unique ID** number. You can find this number on the back of the device and on the device’s packaging.

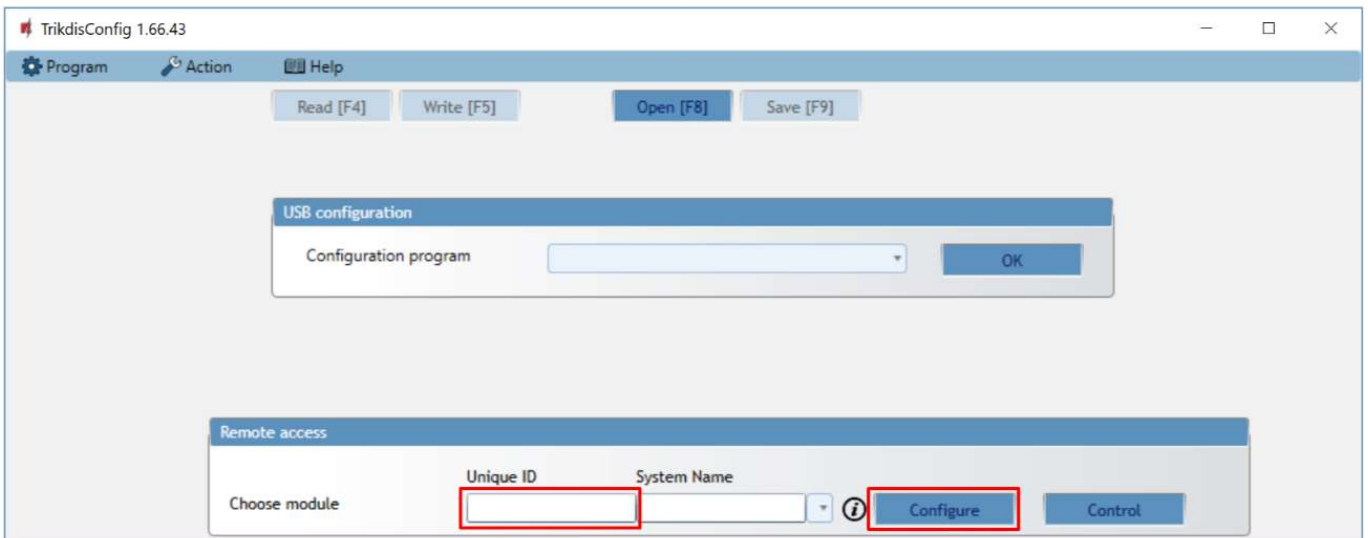

3. (Optional) Enter a desired name for the communicator in the **System Name** field.
4. Click **Configure**.
5. In the window that opens, click **Read [F4]**. If prompted, enter the administrator or installer code.
6. When you are finished setting the desired parameters, click **Write [F5]**. If you are done working with **TrikdisConfig**, click **Disconnect**.

## 7 Testing the G17F GSM communicator

When configuration and installation are complete, perform a system check:

1. To test an input of the communicator, enable it. Check if the events were received by the Central Monitoring Station (CMS) and/or **Protegeus** application.
2. To test the communicator’s outputs, turn them on remotely and check their operation. Ensure that the events were received by the Central Monitoring Station (CMS) and/or **Protegeus** application.



3. Perform a fire alarm test to see if the CMS receives events correctly.

## 8 Updating firmware

**Note:** After connecting the communicator to *TrikdisConfig*, the program will automatically offer to update the firmware if any updates are available. Internet connection is needed for this feature. Antivirus software, firewall or strict internet access settings can block the automatic update feature.

The communicator's firmware can also be updated or changed manually. All prior settings of the communicator remain after an update. If the firmware is installed manually, it can be changed to a newer or an older version. Perform these steps:

1. Launch *TrikdisConfig*.
2. Connect the communicator to the computer using a USB Mini-B cable or connect to the communicator remotely.
  - If a newer version of firmware is available, the program will automatically offer to install it.
3. Open the *TrikdisConfig* window **Firmware**.

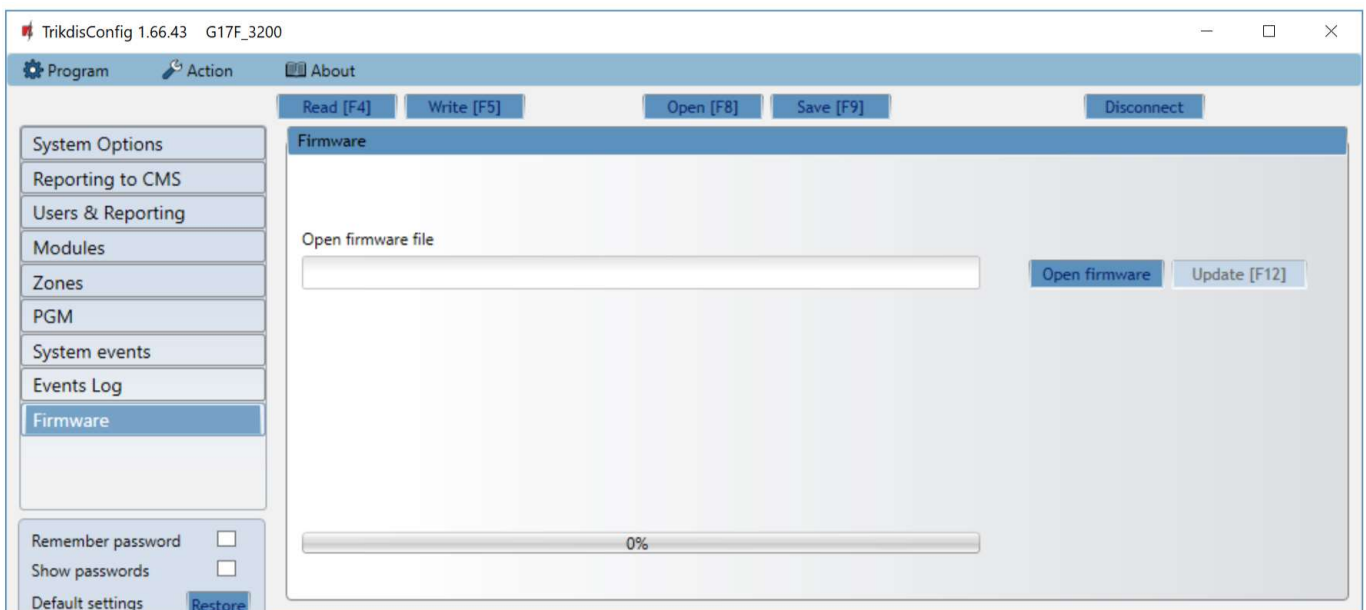

4. Click the button **Open firmware** and choose the required firmware file. The newest firmware files can be downloaded from the webpage [www.trikdis.com](http://www.trikdis.com).
5. Click the **Update [F12]** button.
6. Wait for the update to finish.