

- CAUTION**
- The communicator should be installed and maintained by qualified personnel.
 - Prior to installation, it is advised to read full device installation manual carefully in order to avoid mistakes that can lead to malfunction or even damage the equipment.
 - Disconnect the power supply before making any electrical connections.
 - Changes, modifications or repairs not authorized by the manufacturer shall void your rights under the warranty.

Schematics for wiring the communicator to the security control panel

Following the schematics provided below, wire the communicator to the control panel.

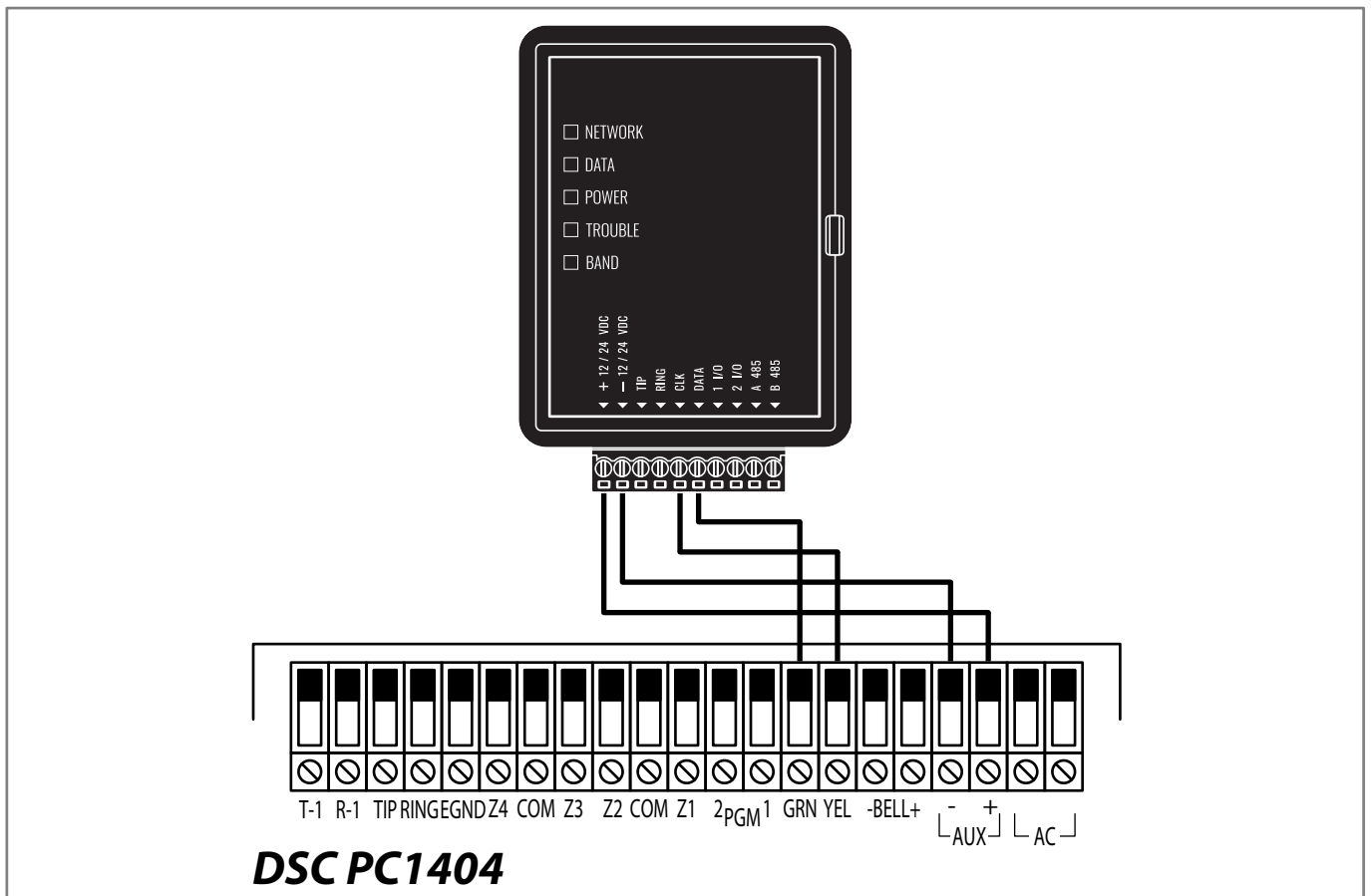

DSC PC1404 panel do not need to be programmed.

LED indication of communicator operation

Indicator	Light status	Description
NETWORK	Off	No connection to cellular network
	Yellow blinking	Connecting to cellular network
	Green solid with yellow blinking	Communicator is connected to cellular network. Yellow blinks count indicates signal strength, 10 blinks max. Sufficient cellular signal strength for 4G network - level 3 (three yellow flashes).
DATA	Off	No unsent events
	Green solid	Unsent events are stored in buffer
	Green blinking	(Configuration mode) Data is being transferred to/from communicator
POWER	Off	Power supply is off or disconnected
	Green solid	Power supply is on with sufficient voltage
	Yellow solid	Power supply voltage is insufficient ($\leq 11.5V$)
	Green solid and yellow blinking	(Configuration mode) Communicator is ready for configuration
	Yellow solid	(Configuration mode) No connection with computer
TROUBLE	Off	No operation problems
	1 red blink	SIM card not found
	2 red blinks	SIM card PIN code problem (incorrect PIN code)
	3 red blinks	Programming problem (No APN)
	4 red blinks	Registration to GSM network problem
	5 red blinks	Registration to GPRS/UMTS network problem
	6 red blinks	No connection with the receiver
	7 red blinks	Lost connection with control panel
	8 red blinks	The entered ICCID number does not match the ICCID number of the SIM card
	Red blinking	(Configuration mode) Memory fault
	Red solid	(Configuration mode) Firmware is corrupted
BAND	1 green blink	None
	2 green blinks	GSM
	3 green blinks	GPRS
	4 green blinks	EDGE
	5 green blinks	HSDPA, HSUPA, HSPA+, WCDMA
	6 green blinks	LTE TDD, LTE FDD

Setting up the GT+ communicator with the app

Download and launch the Protegus application or use the browser version: web.protegus.app. The installer must connect to Protegus with an installer account.

Step 1



Click the "Add new system" button

Step 2

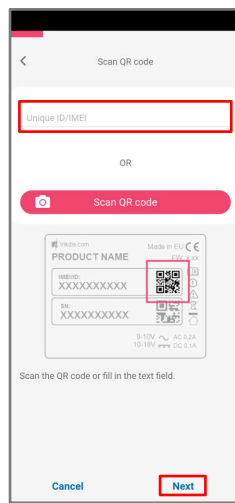

Enter the IMEI number of the communicator

Step 3

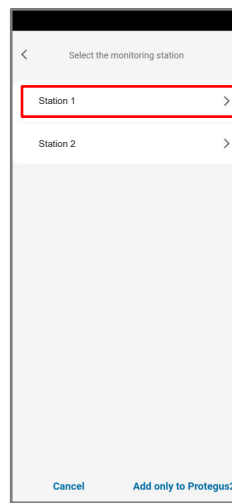

Select security company

Step 4

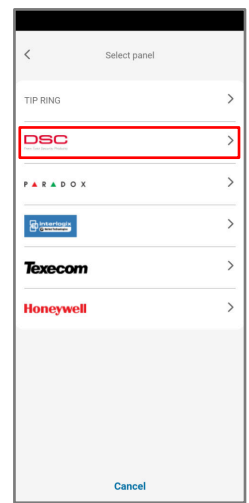

Press "DSC"

Step 5



Press "PC1404"

Step 6

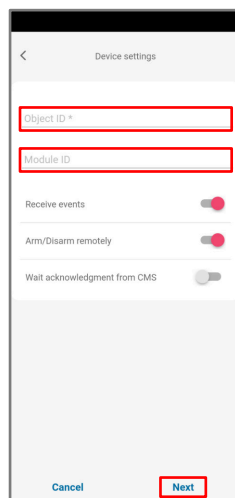

Enter "Object ID" and "Module ID". Press "NEXT"

Step 7

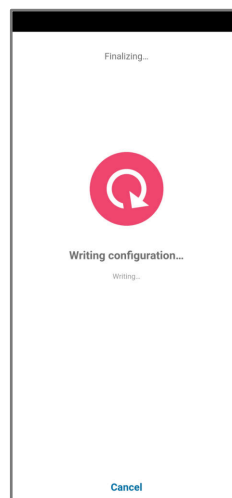

Wait while the configuration is written

Step 8

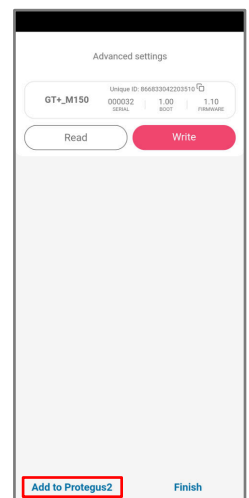

Press "Add to Protegus2"

Setting up the GT+ communicator with the app

Step 9

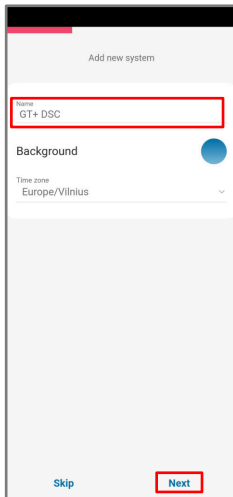

Enter system "Name".
Press "Next"

Step 10

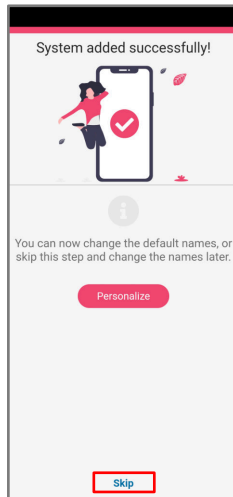

Press "Skip"

Step 11

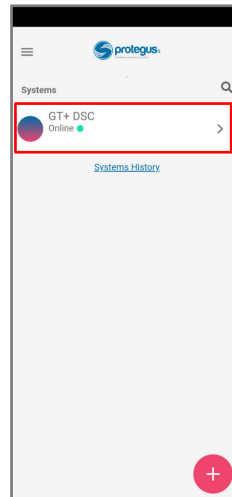

Press on system

Step 12



Wait 1 minute and press
"Transfer"

Step 13

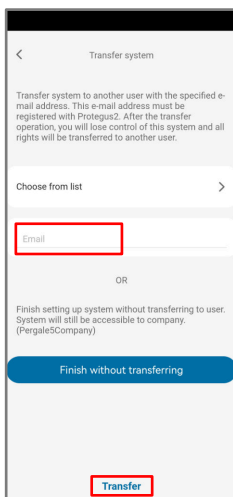

Enter the e-mail of the user
to whom the installer will
transfer the system. Press
"Transfer"

Step 14

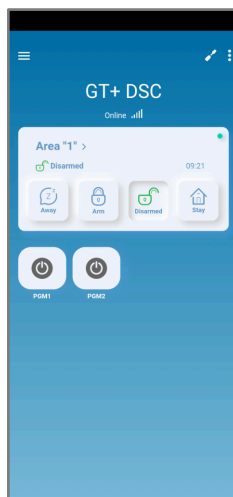

The system will appear in
Protegeus on the user's
phone

After completing the setup and installation perform a system check:

1. Create an event:
 - by arming/disarming the system with the control panel's keypad;
 - by triggering a zone alarm when the security system is armed.
2. Make sure that the event arrives to the CMS (Central Monitoring Station) and the Protegeus app.