

Wiring Trikdis GT+ Cellular Communicator and Programming the Panel Setting up the GT+ for alarming to the CMS and/or Protegus2 app

- CAUTION**
- The communicator should be installed and maintained by qualified personnel.
 - Prior to installation, it is advised to read full device installation manual carefully in order to avoid mistakes that can lead to malfunction or even damage the equipment.
 - Disconnect the power supply before making any electrical connections.
 - Changes, modifications or repairs not authorized by the manufacturer shall void your rights under the warranty.

Schematics for wiring the communicator to the security control panel

Following the schematic provided below, wire the communicator to the control panel.

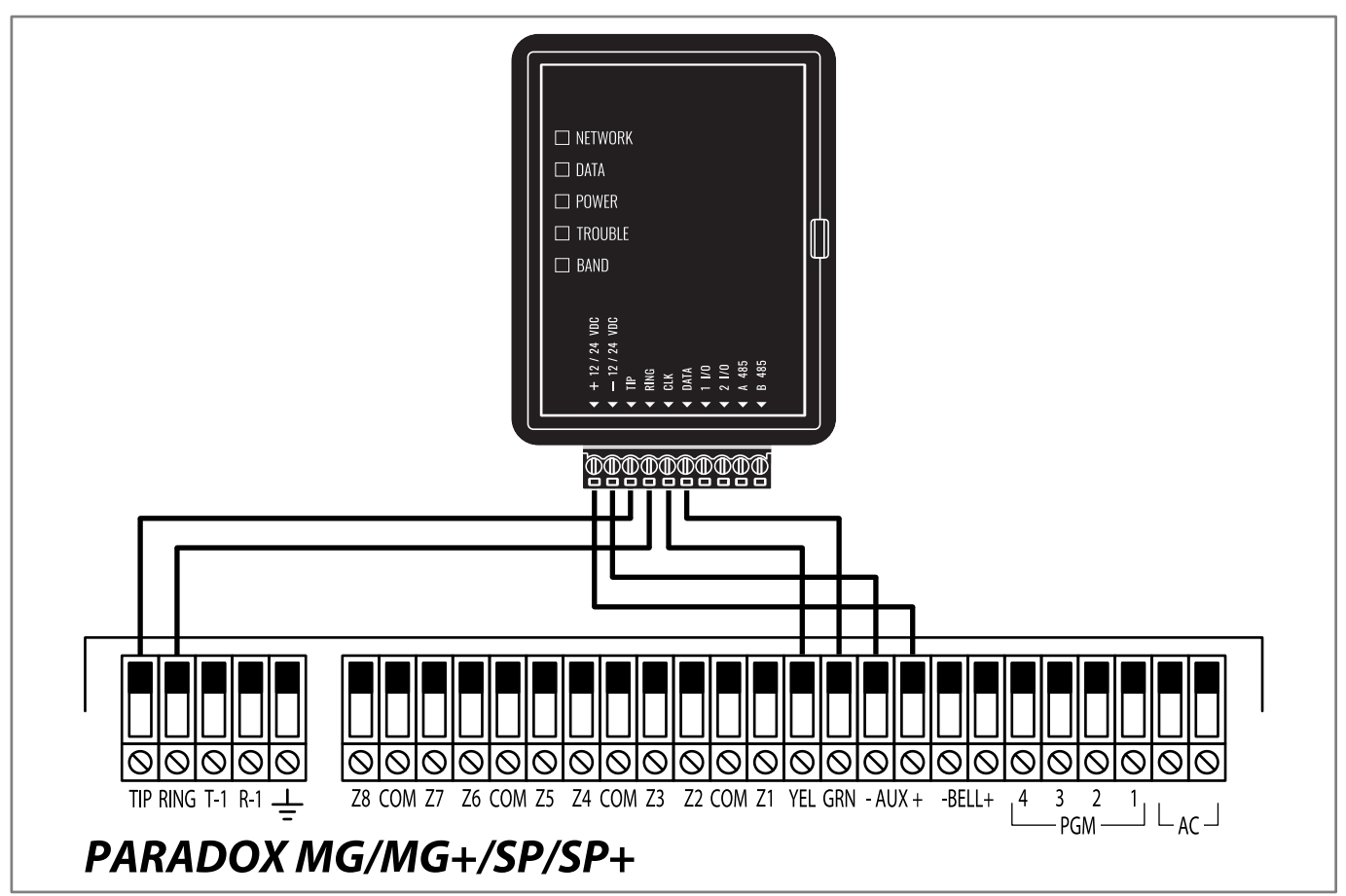

Wiring Trikdis GT+ Cellular Communicator
and Programming the Panel
Setting up the GT+ for alarming to the CMS
and/or Protegus2 app

Programming the PARADOX MG/MG+/SP/SP+ Alarm Panel via the LCD Keypad

Using the control panel’s keypad enter these sections and set them as described:

Enable Contact ID reporting

LCD keypad	Keypad Entry	Action Description
System Off	[ENTER]0000	Enter programming mode.
[] Section	801	Enter section number 801. (Description of general communication dialer options).
801 Options	*****	
	[ENTER][CLEAR]	Save and go to next menu.
[] Section	811	Enter section number 811. (Partition 1 account number).
811 Data	1111	Enter partition 1 account number.
[] Section	812	Enter section number 812. (Partition 2 account number).
812 Data	2222	Enter partition 2 account number.
[] Section	815	Enter section number 815. (Landline Communication Settings).
815 Data	123456	Enter phone number.
	[ENTER]	Press "ENTER" to save.
[] Section	911	Enter section number 911. (WinLoad/BabyWare Options).
911 Data	1234	Enter PC password.
[] Section	[CLEAR]	Press "CLEAR" to exit programming mode.

Wiring Trikdis GT+ Cellular Communicator and Programming the Panel Setting up the GT+ for alarming to the CMS and/or Protegus2 app

LED indication of communicator operation

Indicator	Light status	Description
NETWORK	Off	No connection to cellular network
	Yellow blinking	Connecting to cellular network
	Green solid with yellow blinking (Proper indication)	Communicator is connected to cellular network. Yellow blinks count indicates signal strength, 10 blinks max. Sufficient cellular signal strength for 4G network - level 3 (three yellow flashes).
DATA	Off (Proper indication)	No unsent events
	Green solid	Unsent events are stored in buffer
	Green blinking	(Configuration mode) Data is being transferred to/from communicator
POWER	Off	Power supply is off or disconnected
	Green solid (Proper indication)	Power supply is on with sufficient voltage
	Yellow solid	Power supply voltage is insufficient ($\leq 11.5V$)
	Green solid and yellow blinking	(Configuration mode) Communicator is ready for configuration
	Yellow solid	(Configuration mode) No connection with computer
TROUBLE	Off (Proper indication)	No operation problems
	1 red blink	SIM card not found
	2 red blinks	SIM card PIN code problem (incorrect PIN code)
	3 red blinks	Programming problem (No APN)
	4 red blinks	Registration to GSM network problem
	5 red blinks	Registration to GPRS/UMTS network problem
	6 red blinks	No connection with the receiver
	7 red blinks	Lost connection with control panel
	8 red blinks	The entered ICCID number does not match the ICCID number of the SIM card
	Red blinking	(Configuration mode) Memory fault
Red solid	(Configuration mode) Firmware is corrupted	
BAND	1 green blink	None
	2 green blinks	GSM
	3 green blinks	GPRS
	4 green blinks	EDGE
	5 green blinks	HSDPA, HSUPA, HSPA+, WCDMA
	6 green blinks (Proper indication)	LTE TDD, LTE FDD

Wiring Trikdis GT+ Cellular Communicator and Programming the Panel Setting up the GT+ for alarming to the CMS and/or Protegus2 app

Programming the GT+ communicator for connection with CMS

Open the casing of the **GT+** with a flat-head screwdriver.

Insert SIM card into the holder. Ensure that the SIM card is activated. Ensure that mobile internet service (mobile data) is enabled. To avoid entering the PIN code in **TrikdisConfig**, insert the SIM card into your mobile phone and turn off the PIN request function.

Using a USB-C cable connect the **GT+** to the computer.

Run **TrikdisConfig**. The software will automatically recognize the connected communicator and will open a window for configuration.

1. Enter Object ID (account) number provided by the Central Monitoring Station (6 characters, 0-9, A-F. Do not use FFFE, FFFF Object ID).

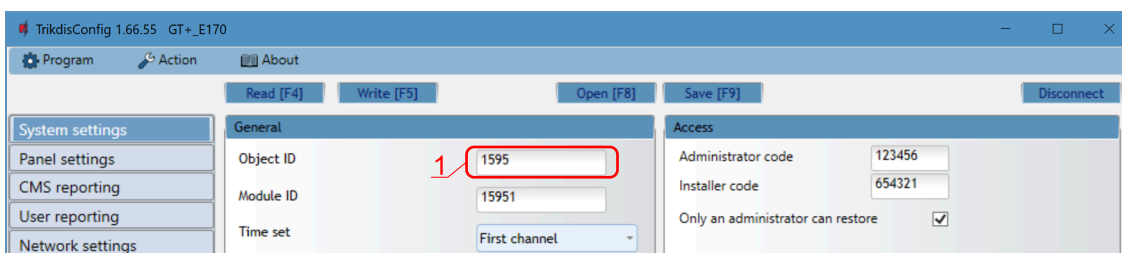

2. Select AUTO.
3. Select "**7. Paradox SP+/MG+ series KeyBus**" security panel model.
4. Select **Remote Arm/Disarm** if you want users to be able to control the panel in Protegus2 app with their keypad code.
5. For the direct control of Paradox panel enter **Security panel PC download password**. It must match the password that is entered in the control panel.

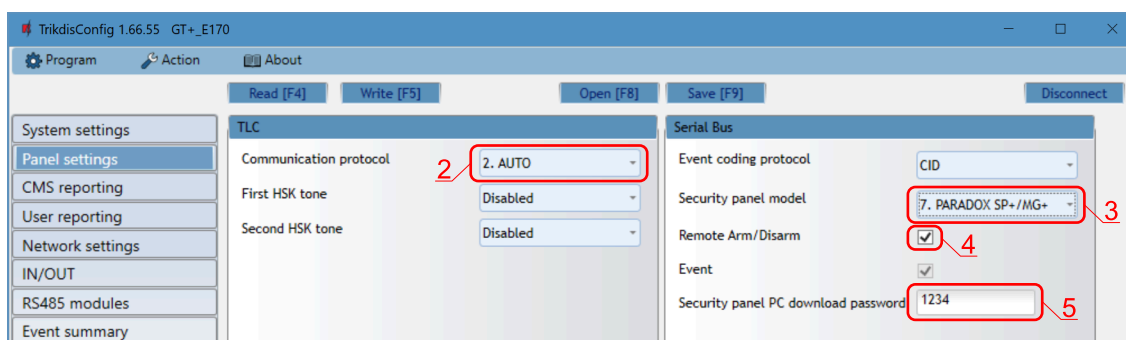

6. Select the IP connection method.
7. Select the protocol type for event messages: TRK8 (to TRIKDIS receivers), DC-09_2007 or DC-09_2012 (to universal receivers).
8. Enter the **Encryption key** that is set in the receiver.
9. Enter the receiver's **Domain or IP** address.
10. Enter receiver's network **Port** number.
11. Choose event transmission protocol (**TCP or UDP**) in which events should be sent.
12. (Recommended) Configure **Primary channel Backup** settings.

Wiring Trikdis GT+ Cellular Communicator and Programming the Panel Setting up the GT+ for alarming to the CMS and/or Protegus2 app

Programming the GT+ communicator for connection with CMS

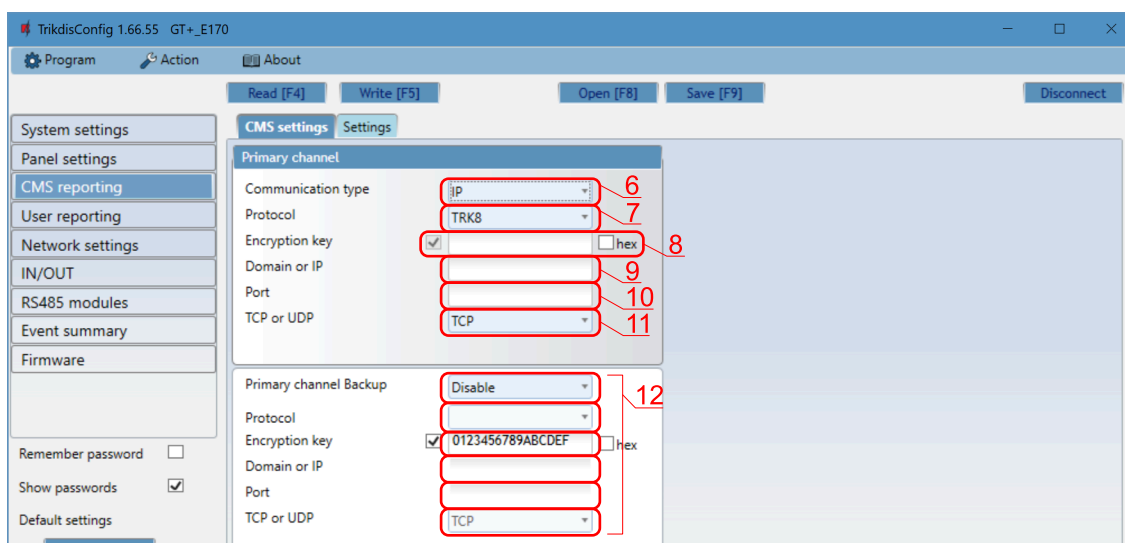

13. Enter **SIM card PIN** code.
14. Change the **APN** name. APN can be found on the website of the SIM card operator (“internet” is universal and works in many operator networks).
15. Google DNS server is set by default. Regardless of IP settings, make sure the DNS addresses match those supported by your ISP.
16. Google DNS server is set by default. Regardless of IP settings, make sure the DNS addresses match those supported by your ISP.
17. After finishing configuration, click **Write [F5]** and disconnect the USB cable.

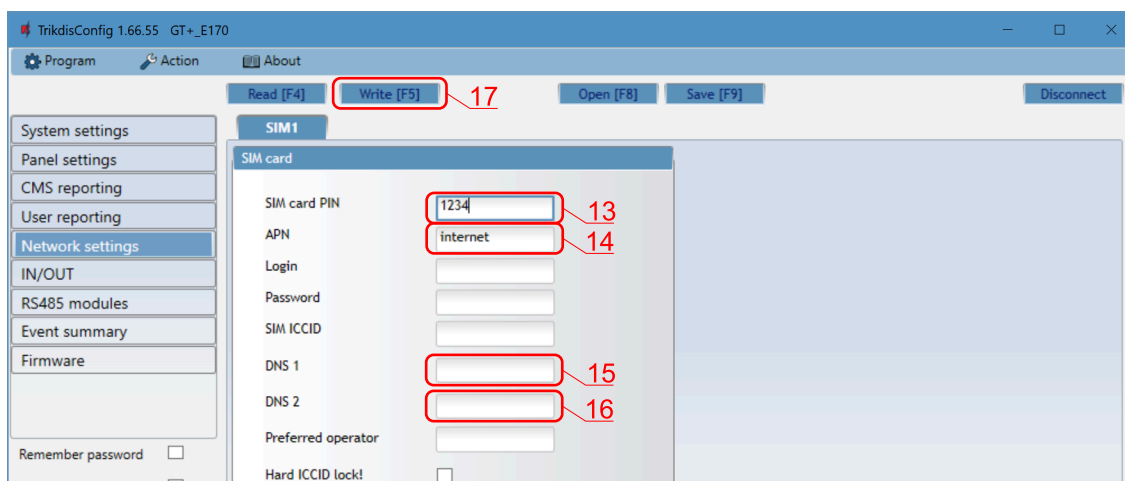

After completing the setup and installation, turn off the power supply to the control panel. Wait 1 minute. Turn on the power supply to the security panel. Wait until the communicator establishes a connection with the mobile network.

Wiring Trikdis GT+ Cellular Communicator and Programming the Panel Setting up the GT+ for alarming to the CMS and/or Protegus2 app

Adding the security system to Protegus2 app

Download and launch the Protegus2 application or use the browser version: web.protegus.app. The user must connect to Protegus2 with their account.

Step 1



Click the "Add new system" button

Step 2

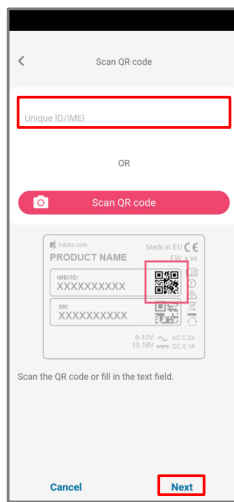

Enter the IMEI number of the communicator. Press "Next"

Step 3

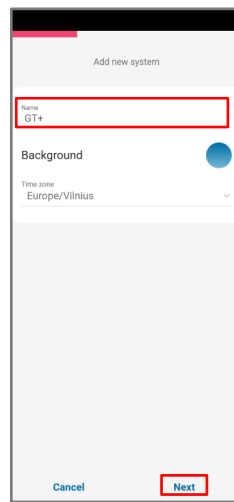

Enter system "Name". Press "Next"

Step 4

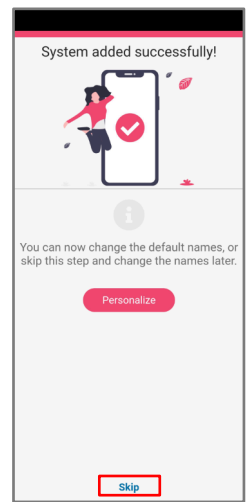

Press "Skip"

Step 5

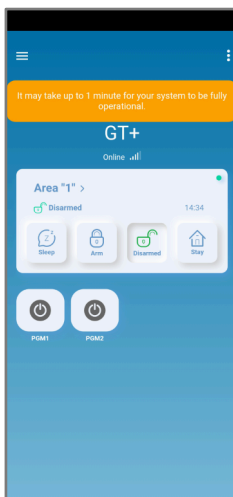

Wait 1 minute

Step 6

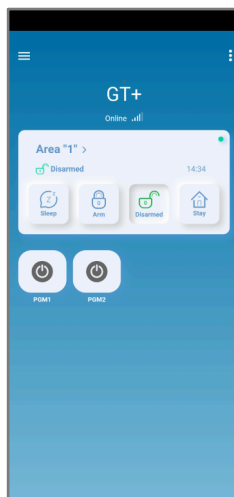

The installation process of the security system in Protegus2 is completed

After completing the setup and installation perform a system check:

1. Create an event:
 - by arming/disarming the system with the control panel's keypad;
 - by triggering a zone alarm when the security system is armed.
2. Make sure that the event arrives to the CMS (Central Monitoring Station) and the Protegus2 app.